

INSTRUCTIONS - INSTRUCCIONES

SlimDeco

Concept Concepto P

2 Panneaux Panels Paneles

Doc.Multi.
SLD.NdP.
Concept.P.
2p.V1

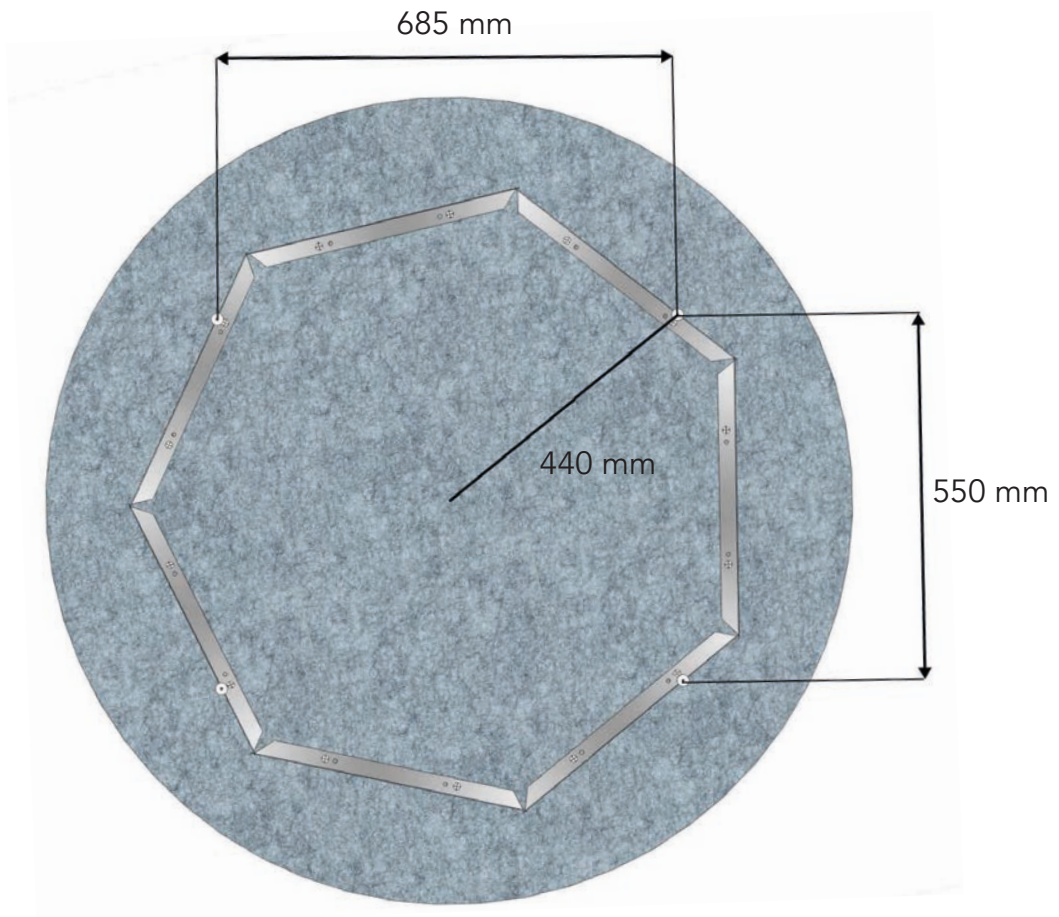
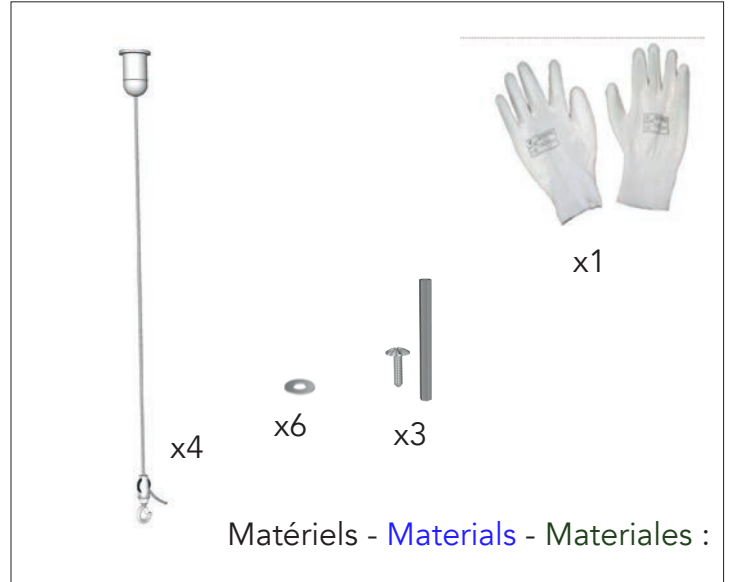
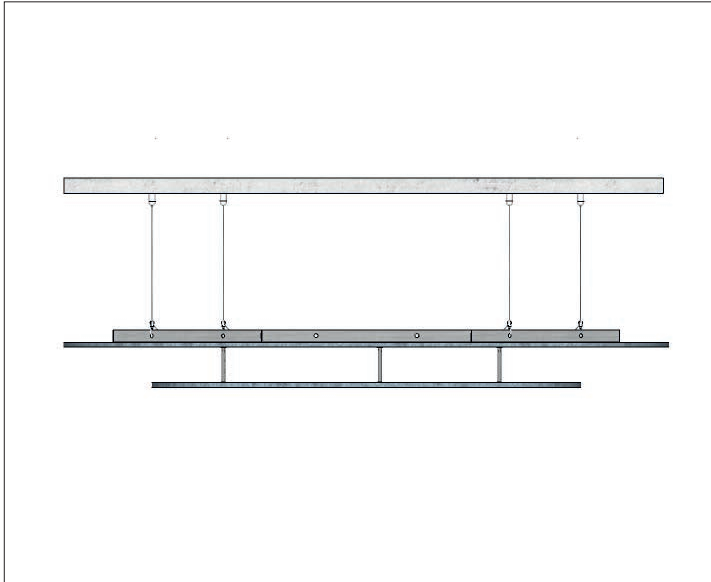

Préparation du Concept :

Concept preparation :

Preparación del concepto :

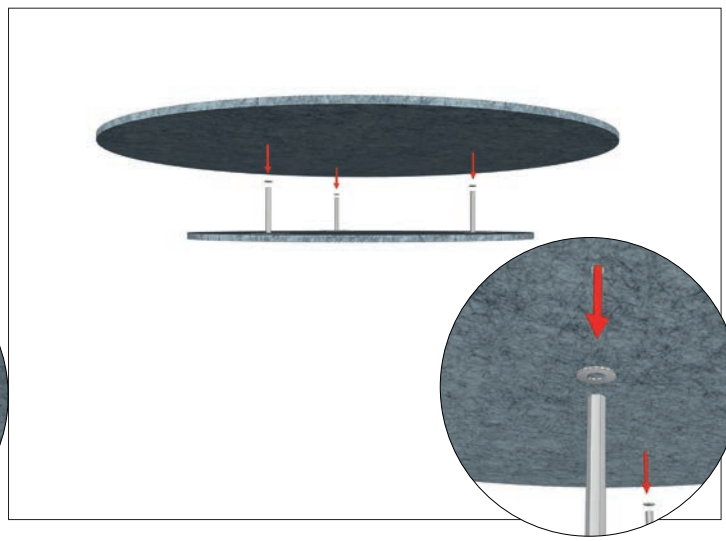
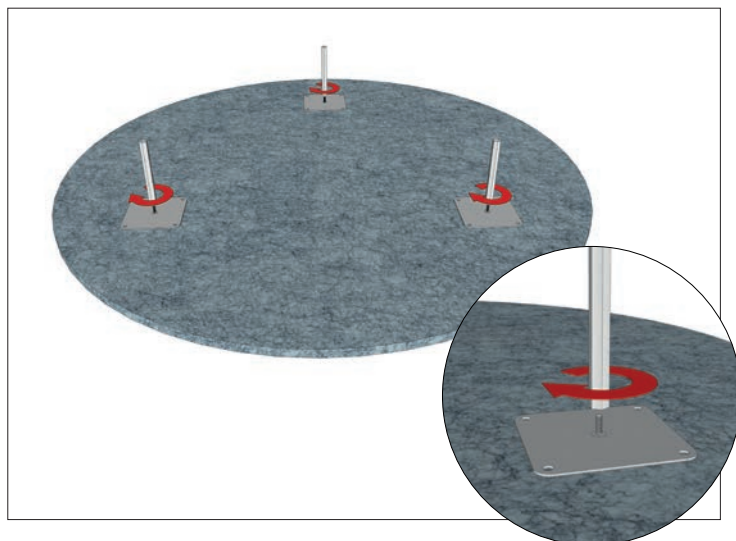

Visser les entretoises sur les patères au dos des panneaux.
Screw the spacers onto the pegs on the back of the panels.
Atornille los espaciadores en las clavijas en la parte posterior de los paneles.

Placer correctement le panneau 850.
Les entretoises face aux trous du panneau 1200.
Position the 850 panel correctly. The spacers face the holes in the 1200 panel.
Coloque correctamente el panel 850. Los espaciadores miran hacia los orificios del panel 1200.

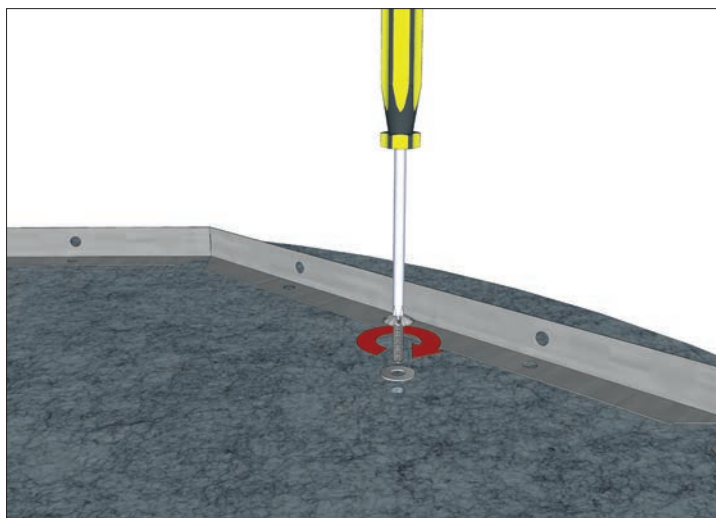

A l'aide de vis, fixer le panneau 1200 aux entretoises du panneau 850.
Using screws, fix the 1200 panel to the braces of the 850 panel.
Con tornillos, fije el panel 1200 a las abrazaderas del panel 850.

Préparation du plafond et accrochage du Concept :
Preparing the ceiling and hanging the Concept :
Preparando el techo y colgando el Concept :

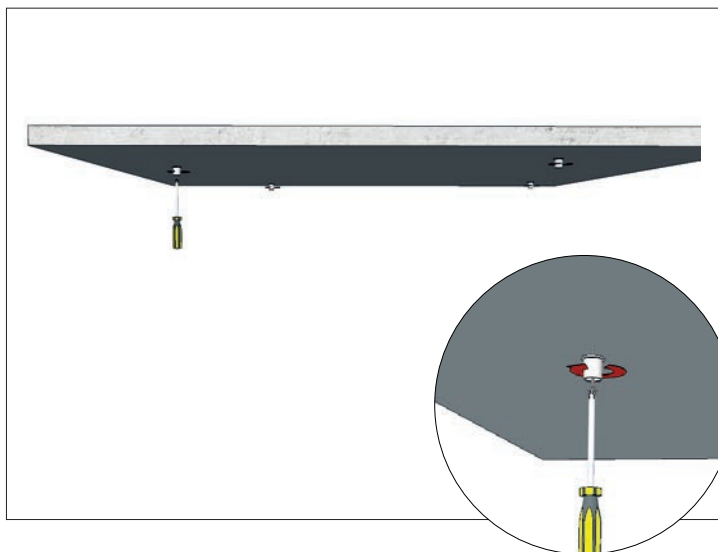

Repérer le placement des élingues, choisir la qualité de la cheville et des vis, puis fixer les embouts.

Mark the placement of the slings, choose the quality of the dowel and the screws, then fix the ends.

Marque la ubicación de las eslingas, elija la calidad de la espiga y los tornillos, luego fije los extremos.

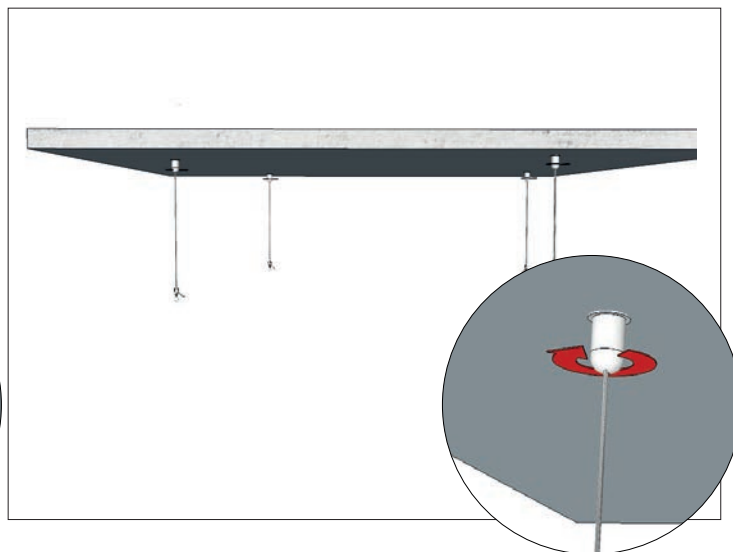

Visser les élingues aux embouts.

Screw the slings to the ends.

Atornille las eslingas hasta los extremos.

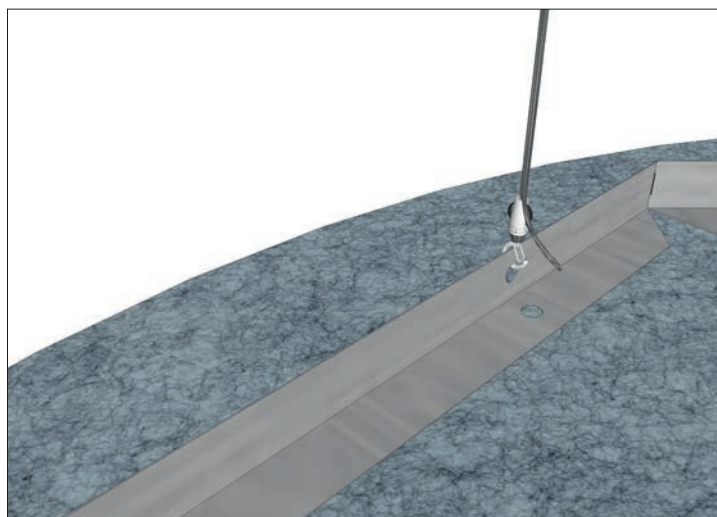

Accrocher le concept aux élingues.

Hanging concept on slings.

Colgar el concepto en eslingas.



A l'aide d'un niveau, régler la hauteur du concept.

Using a level, adjust the height of the concept.

Usando un nivel, ajuste la altura del concepto.

texdecor

Collection Coleccion : SlimDeco - Concept Concepto P - 2 panneaux panels paneles

Date de parution - Release date - Fecha de parution : Janvier - January - Enero 2022

siège social
 2 rue d'hem - 59780 Willems - France
 tel +33 (0)3 20 61 78 37 / Fax +33 (0)3 20 61 75 64

www.texdecor.com

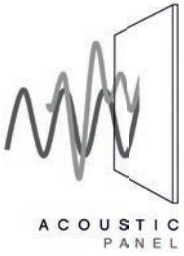

INSTRUCTIONS - INSTRUCCIONES
SlimDeco
Concept Concepto P
3 Panneaux Panels Paneles

Doc.Multi.
SLD.NdP.
Concept.P.
3p.V1

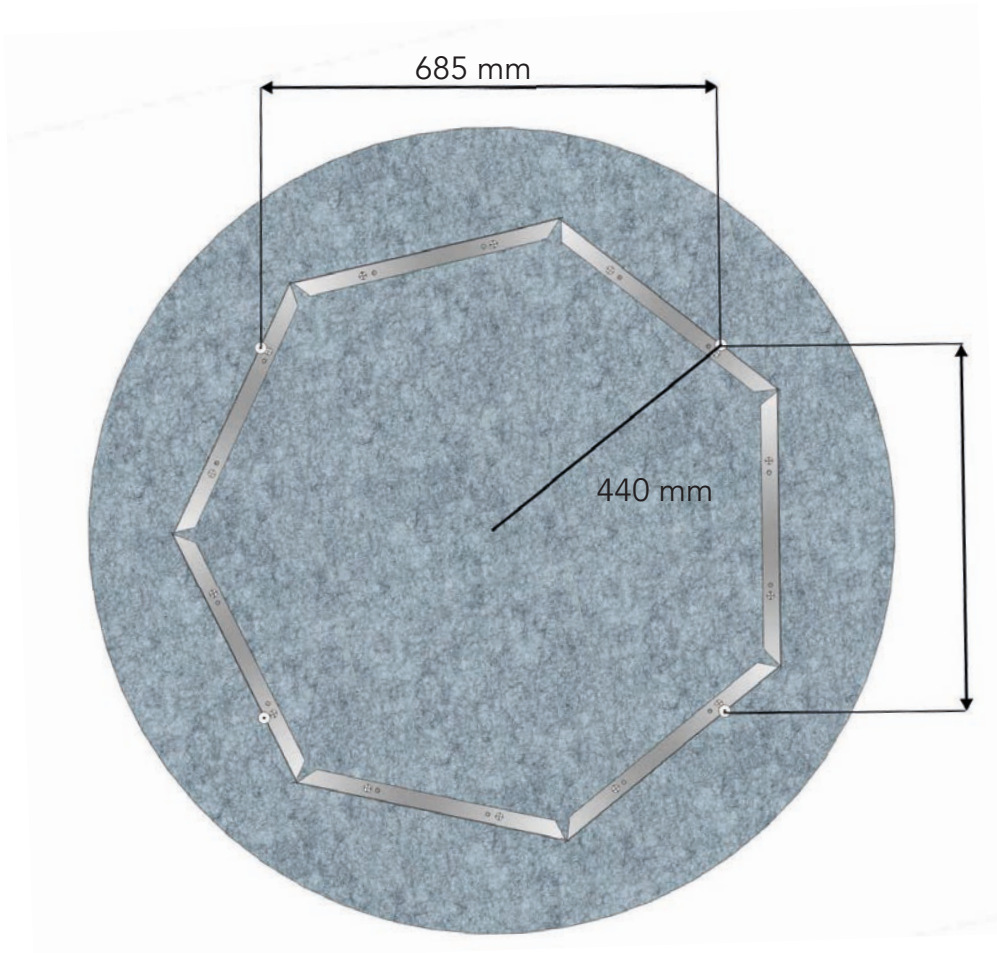
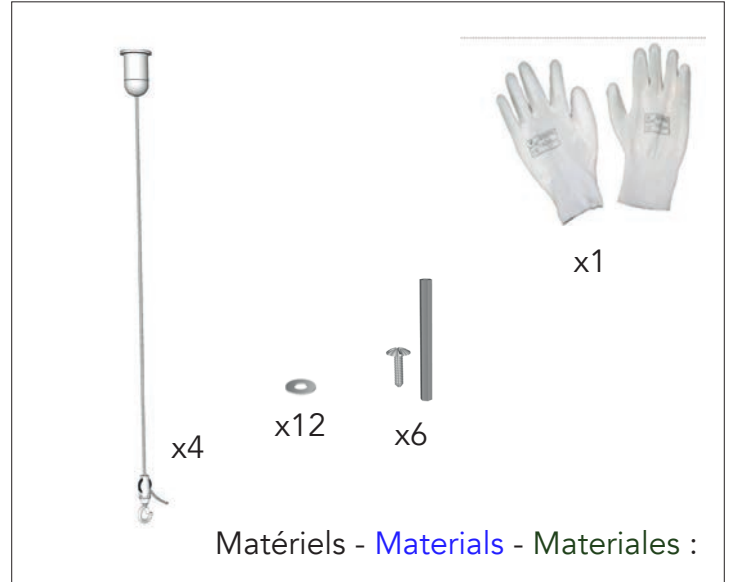
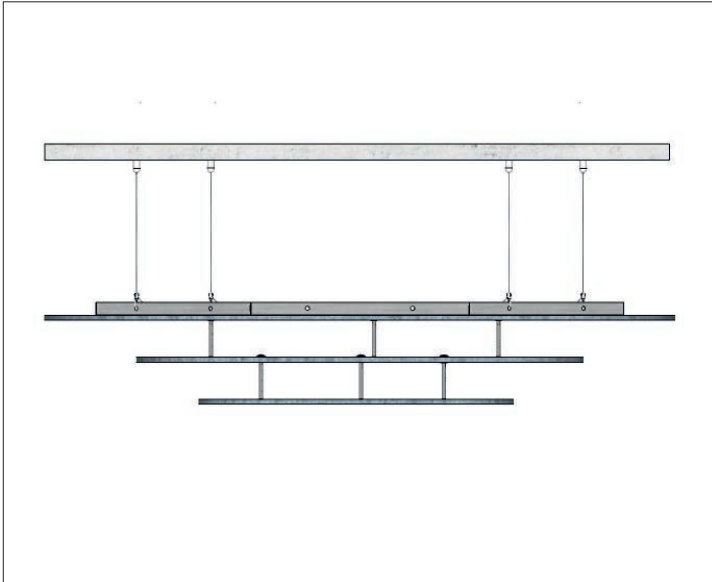

Préparation du Concept :

Concept preparation :

Preparación del concepto :

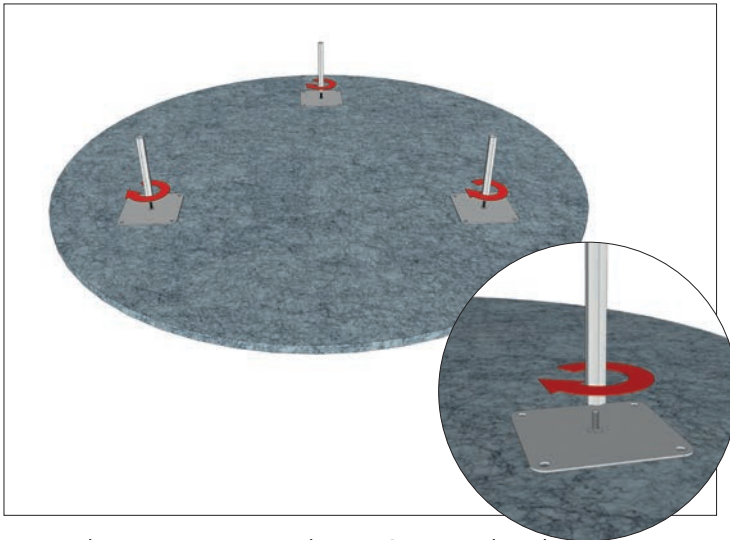

Visser les entretoises sur les patères au dos des panneaux.

Screw the spacers onto the pegs on the back of the panels.

Atornille los espaciadores en las clavijas en la parte posterior de los paneles.

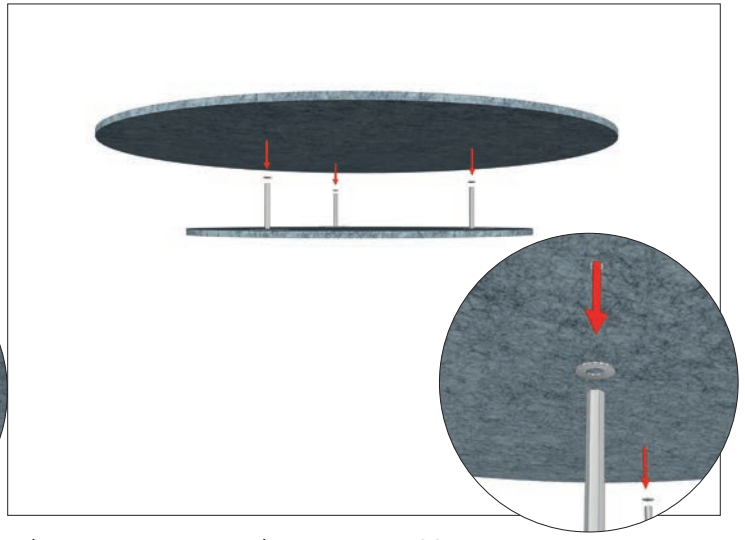

Placer correctement le panneau 600.

Les entretoises face aux trous du panneau 850.

Position the 600 panel correctly. The spacers face the holes in the 850 panel.

Coloque correctamente el panel 600. Los espaciadores miran hacia los orificios del panel 850.

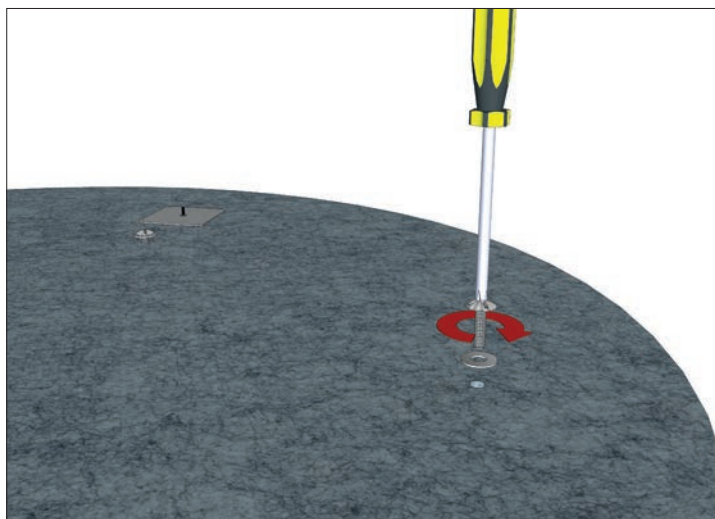

A l'aide de vis, fixer le panneau 850 aux entretoises du panneau 600.

Using screws, fix the 850 panel to the braces of the 600 panel.

Con tornillos, fije el panel 850 a las abrazaderas del panel 600.

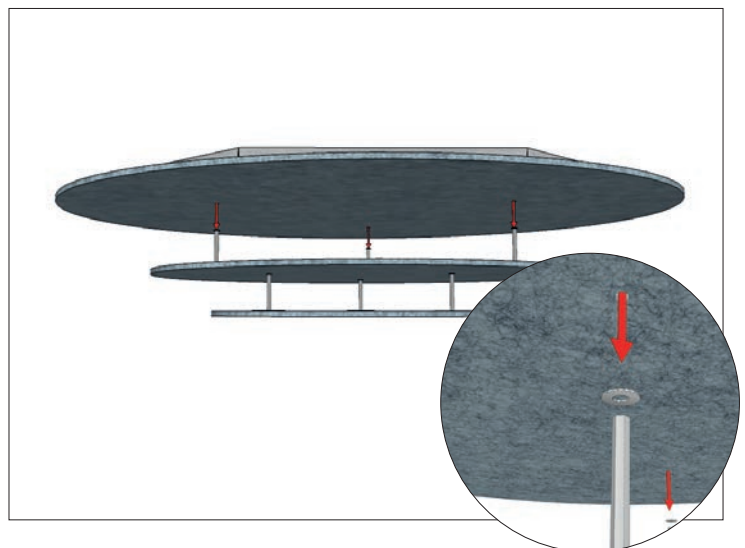

Placer correctement l'ensemble des panneaux 600 et 850. Les entretoises face aux trous du panneau 1200.

Position all the 600 and 850 panels correctly. The spacers face the holes in the 1200 panel.

Coloque correctamente todos los paneles 600 y 850. Los espaciadores miran hacia los orificios del panel 1200.

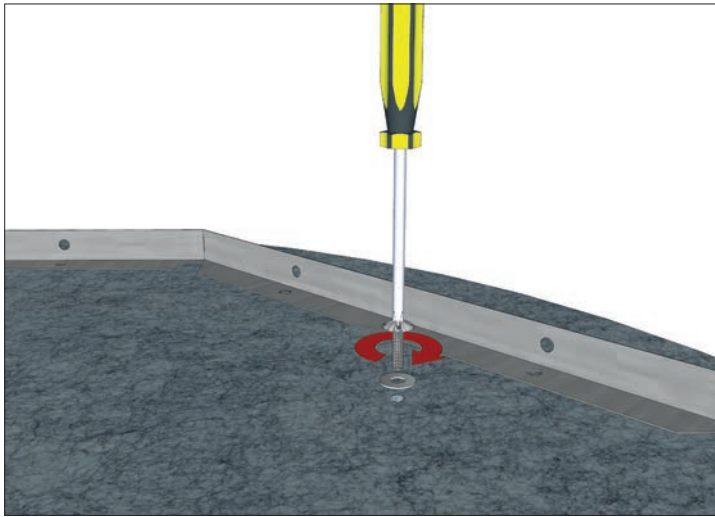

A l'aide de vis, fixer le panneau 1200 aux entraisés du panneau 850.

Using screws, fix the 1200 panel to the braces of the 850 panel.

Con tornillos, fije el panel 1200 a las abrazaderas del panel 850.

Préparation du plafond et accrochage du Concept :
Preparing the ceiling and hanging the Concept :
Preparando el techo y colgando el Concept :

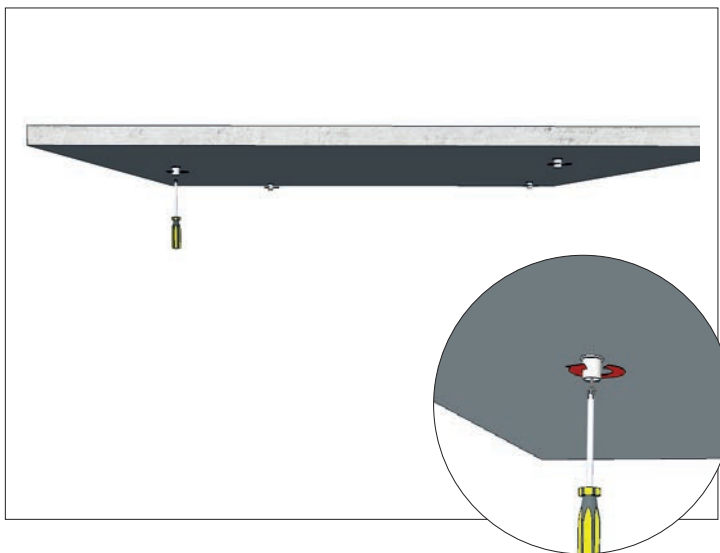

Repérer le placement des élingues, choisir la qualité de la cheville et des vis, puis fixer les embouts.

Mark the placement of the slings, choose the quality of the dowel and the screws, then fix the ends.

Marque la ubicación de las eslingas, elija la calidad de la espiga y los tornillos, luego fije los extremos.

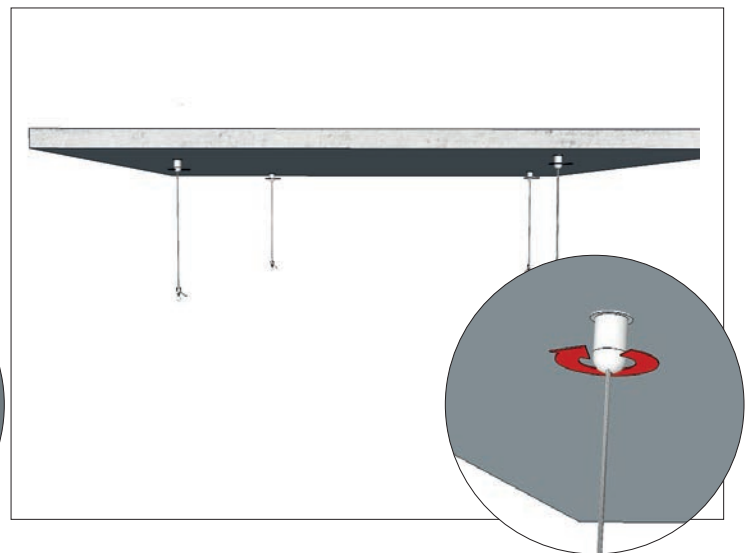

Visser les élingues aux embouts.

Screw the slings to the ends.

Atornille las eslingas hasta los extremos.

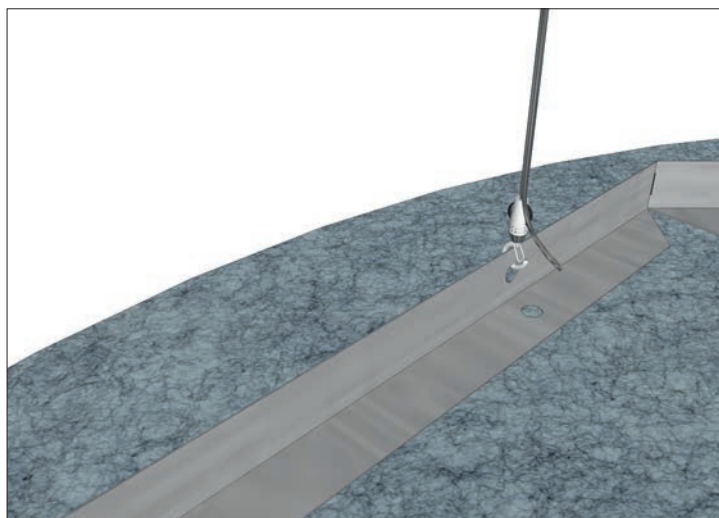

Accrocher le concept aux élingues.
[Hanging concept on slings.](#)
Colgar el concepto en eslingas.



A l'aide d'un niveau, régler la hauteur du concept.
[Using a level, adjust the height of the concept.](#)
Usando un nivel, ajuste la altura del concepto.

texdecor

Collection Coleccion : SlimDeco - Concept Concepto P - 3 panneaux panels paneles

Date de parution - Release date - Fecha de parution : Janvier - January - Enero 2022

siège social
2 rue d'hem - 59780 Willems - France
tel +33 (0)3 20 61 78 37 / Fax +33 (0)3 20 61 75 64

www.texdecor.com

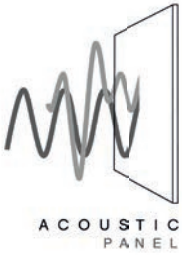

INSTRUCTIONS - INSTRUCCIONES

SlimDeco

Concept Concepto R

2 Panneaux Panels Paneles

Doc.Multi.
SLD.NdP.
Concept.R.
2p.V1

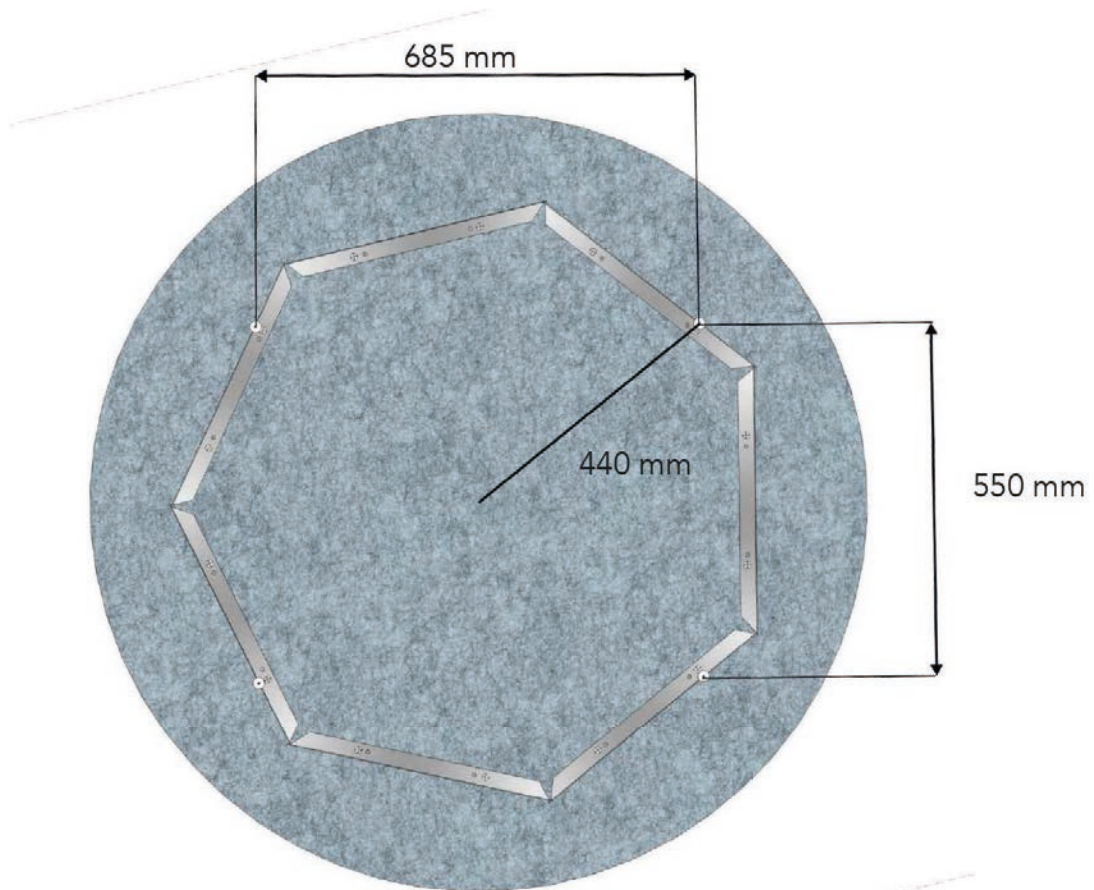
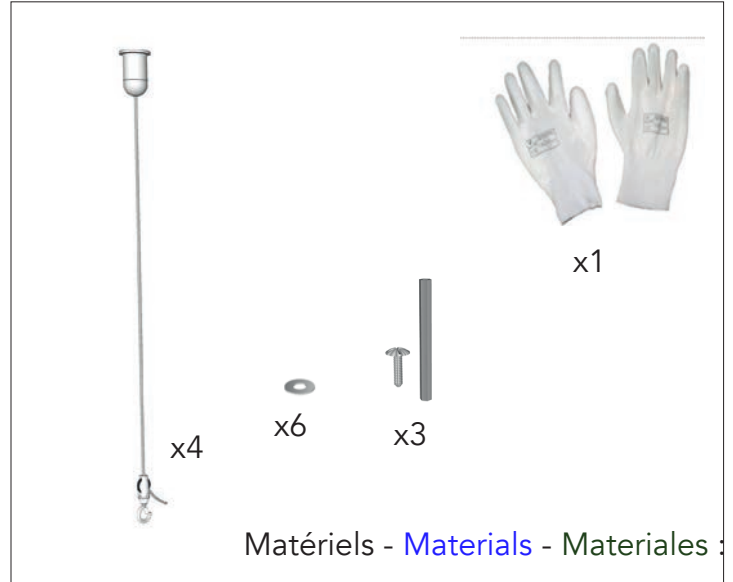
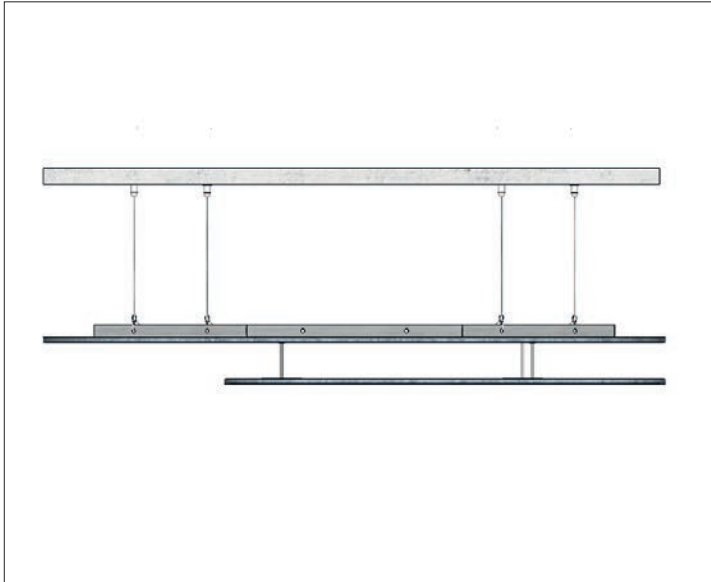

Préparation du Concept :

Concept preparation :

Preparación del concepto :

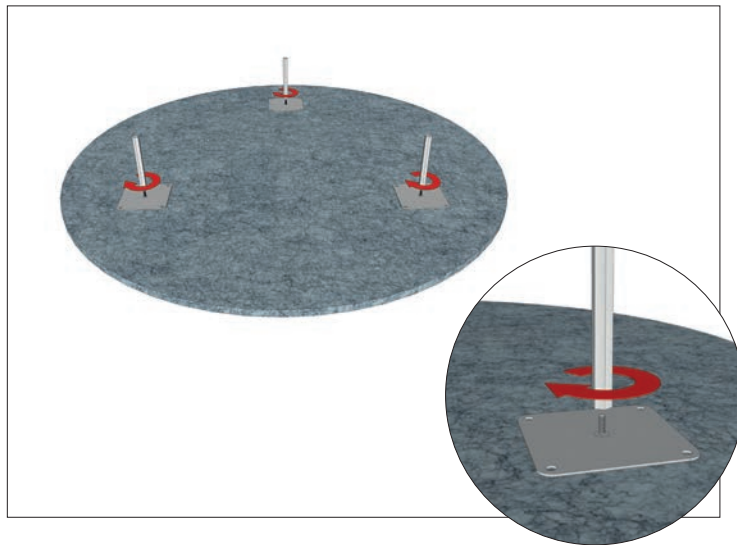

Visser les entretoises sur les patères au dos des panneaux.

Screw the spacers onto the pegs on the back of the panels.

Atornille los espaciadores en las clavijas en la parte posterior de los paneles.

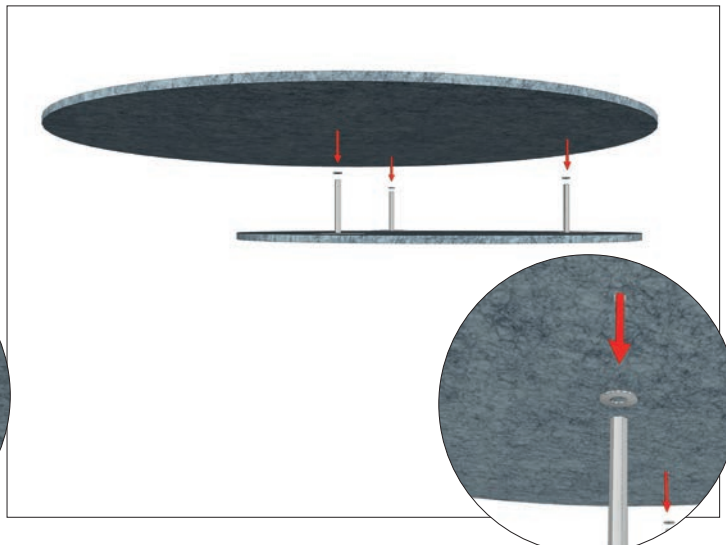

Placer correctement le panneau 850.

Les entretoises face aux trous du panneau 1200.

Position the 850 panel correctly. The spacers face the holes in the 1200 panel.

Coloque correctamente el panel 850. Los espaciadores miran hacia los orificios del panel 1200.

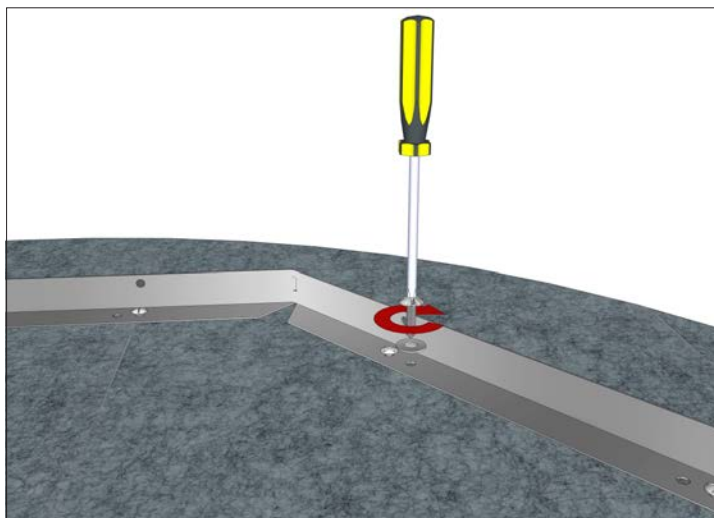

A l'aide de vis, fixer le panneau 1200 aux entretoises du panneau 850.

Using screws, fix the 1200 panel to the braces of the 850 panel.

Con tornillos, fije el panel 1200 a las abrazaderas del panel 850.

Préparation du plafond et accrochage du Concept :
Preparing the ceiling and hanging the Concept :
Preparando el techo y colgando el Concept :

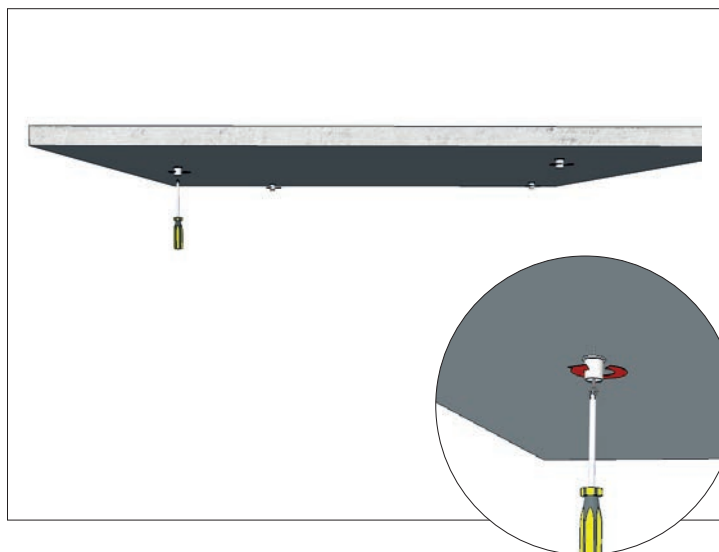

Repérer le placement des élingues, choisir la qualité de la cheville et des vis, puis fixer les embouts.

Mark the placement of the slings, choose the quality of the dowel and the screws, then fix the ends.

Marque la ubicación de las eslingas, elija la calidad de la espiga y los tornillos, luego fije los extremos.

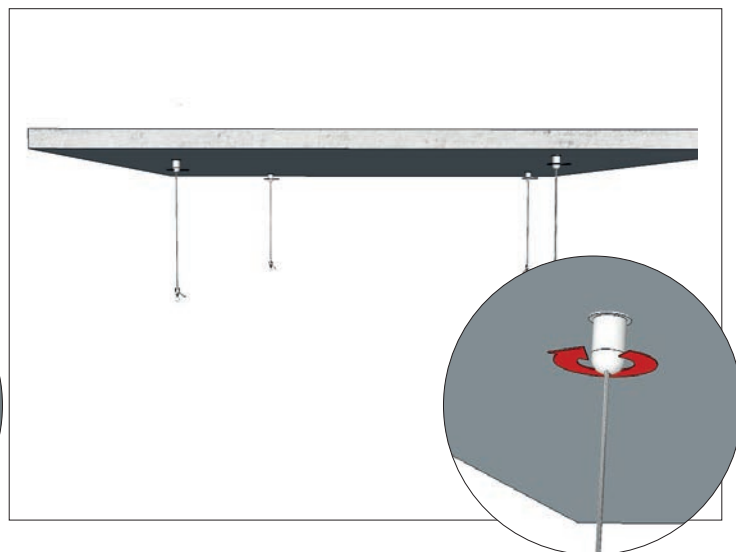

Visser les élingues aux embouts.

Screw the slings to the ends.

Atornille las eslingas hasta los extremos.

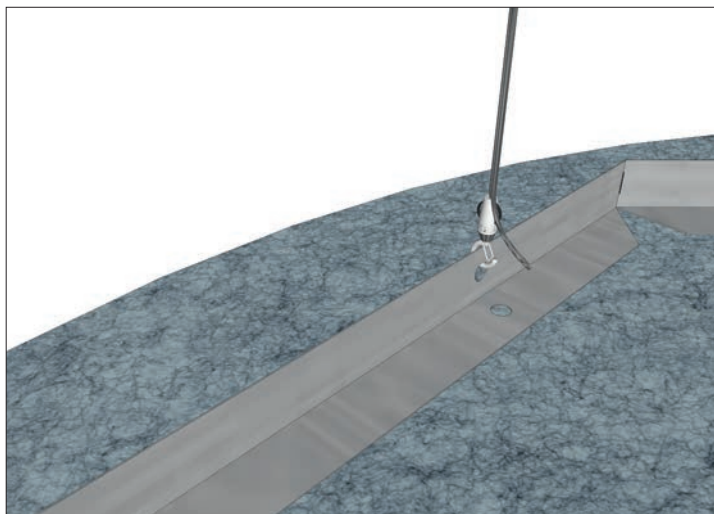

Accrocher le concept aux élingues.

Hanging concept on slings.

Colgar el concepto en eslingas.



A l'aide d'un niveau, régler la hauteur du concept.

Using a level, adjust the height of the concept.

Usando un nivel, ajuste la altura del concepto.

texdecor

Collection Coleccion : SlimDeco - Concept Concepto R - 2 panneaux panels paneles

Date de parution - Release date - Fecha de parution : Janvier - January - Enero 2022

siège social
 2 rue d'hem - 59780 Willems - France
 tel +33 (0)3 20 61 78 37 / Fax +33 (0)3 20 61 75 64

www.texdecor.com

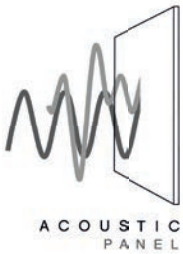

INSTRUCTIONS - INSTRUCCIONES
SlimDeco
Concept Concepto R
3 Panneaux Panels Paneles

Doc.Multi.
SLD.NdP.
Concept.R.
3p.V1

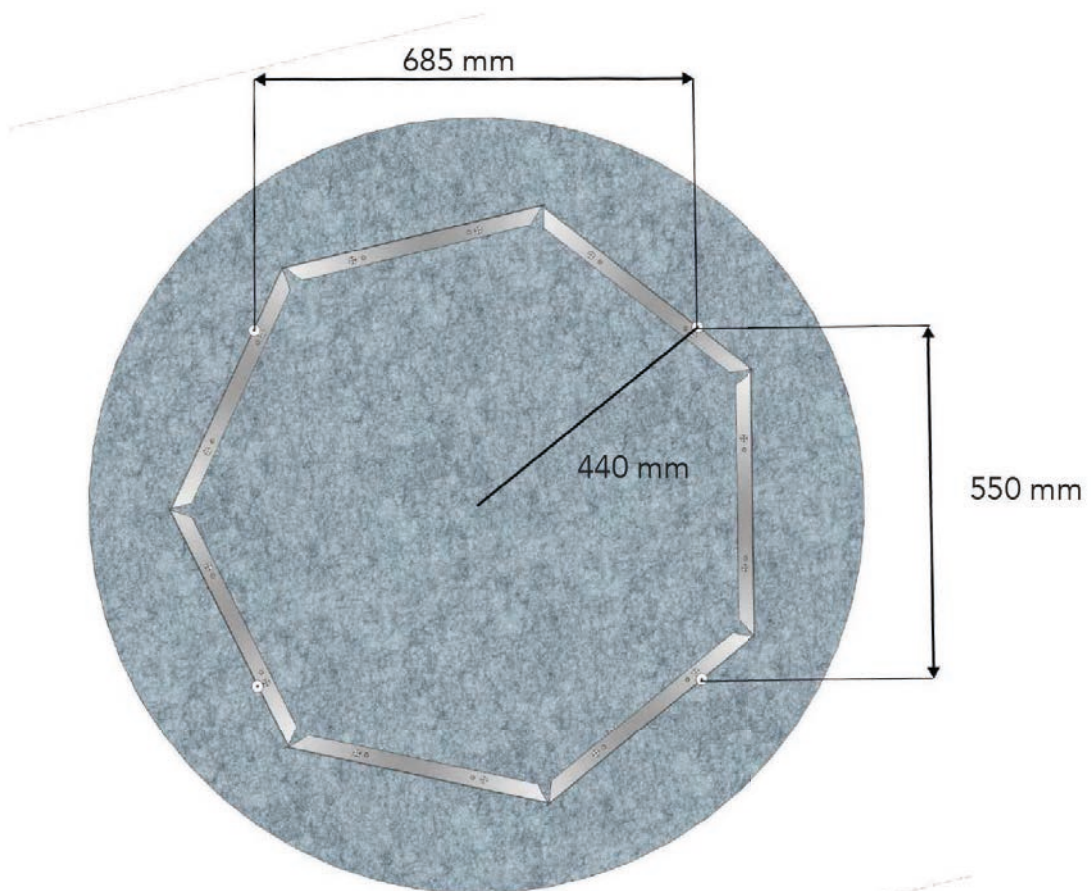
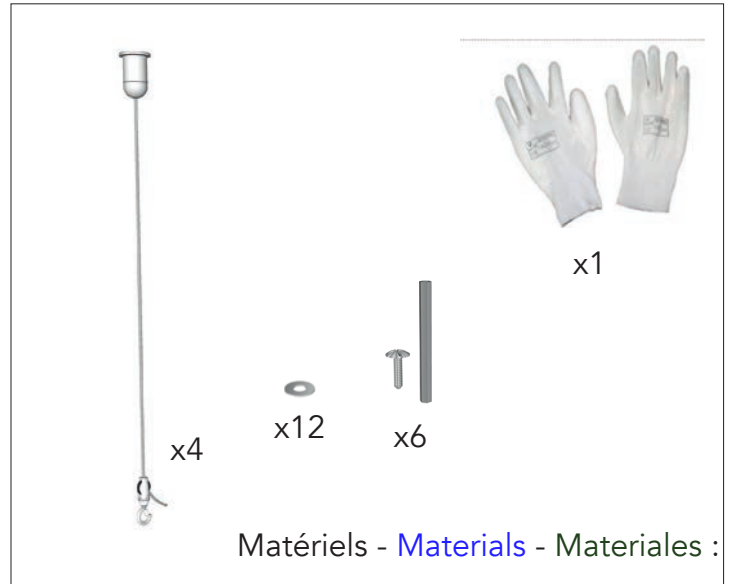
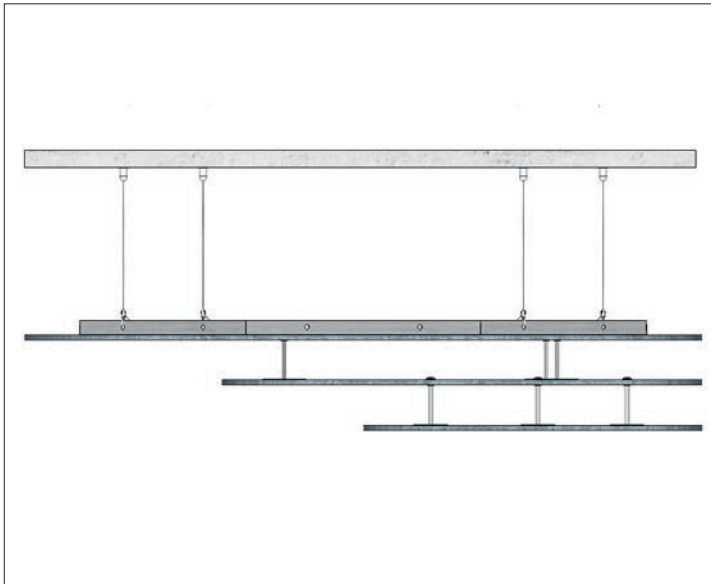

Préparation du Concept :

Concept preparation :

Preparación del concepto :

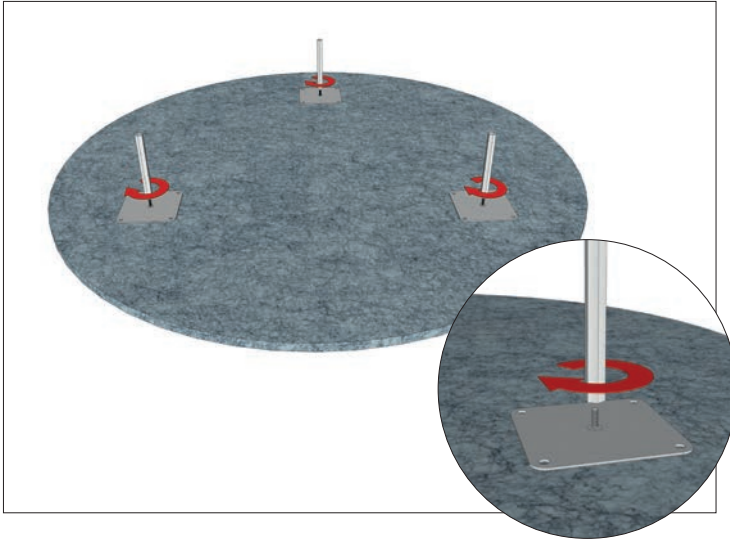

Visser les entretoises sur les patères au dos des panneaux.
Screw the spacers onto the pegs on the back of the panels.
Atornille los espaciadores en las clavijas en la parte posterior de los paneles.

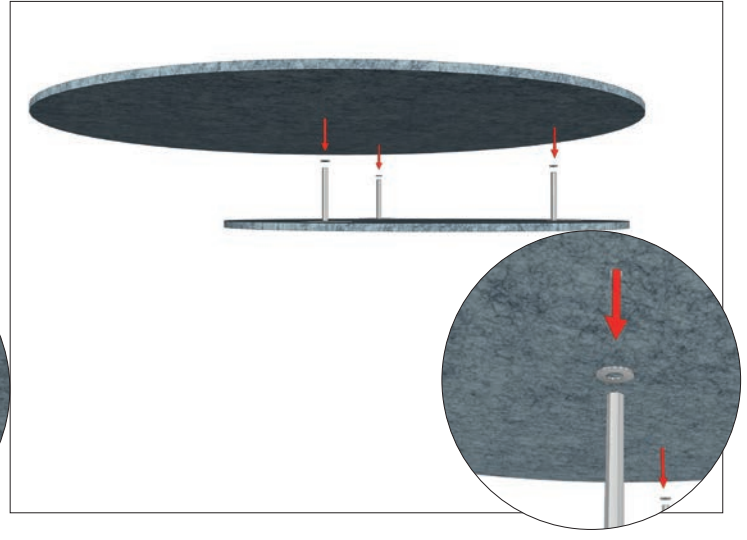

Placer correctement le panneau 600.
Les entretoises face aux trous du panneau 850.
Position the 600 panel correctly. The spacers face the holes in the 850 panel.
Coloque correctamente el panel 600. Los espaciadores miran hacia los orificios del panel 850.

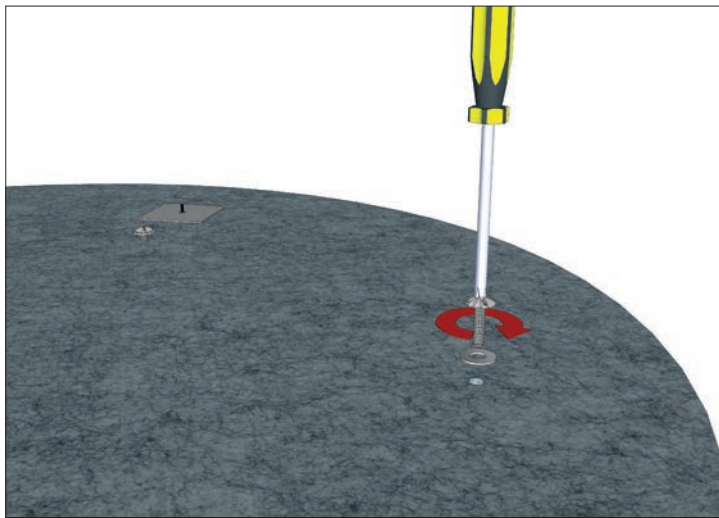

A l'aide de vis, fixer le panneau 850 aux entretoises du panneau 600.
Using screws, fix the 850 panel to the braces of the 600 panel.
Con tornillos, fije el panel 850 a las abrazaderas del panel 600.

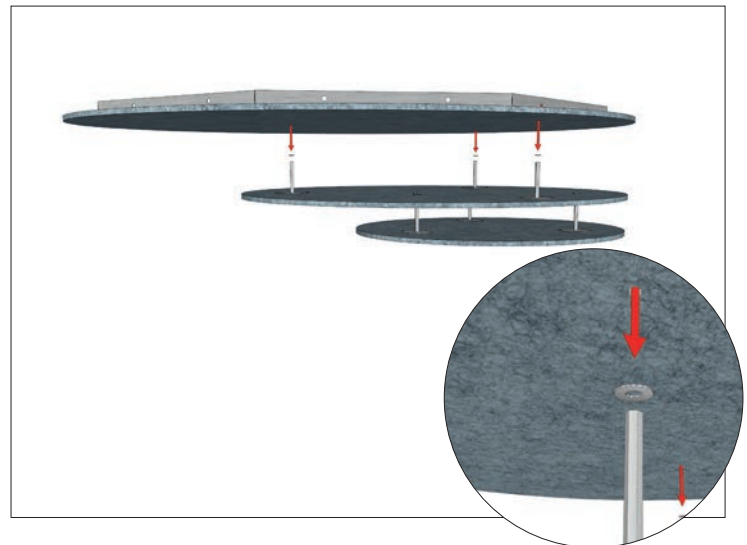

Placer correctement l'ensemble des panneaux 600 et 850. Les entretoises face aux trous du panneau 1200.
Position all the 600 and 850 panels correctly. The spacers face the holes in the 1200 panel.
Coloque correctamente todos los paneles 600 y 850. Los espaciadores miran hacia los orificios del panel 1200.

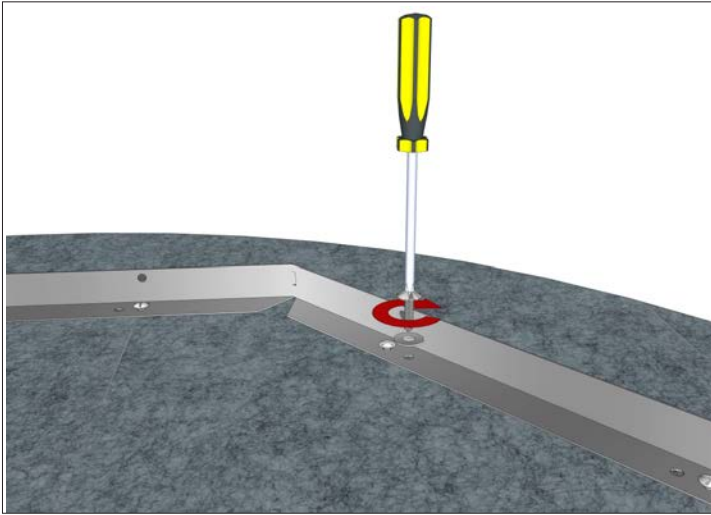

A l'aide de vis, fixer le panneau 1200 aux entrais du panneau 850.

Using screws, fix the 1200 panel to the braces of the 850 panel.

Con tornillos, fije el panel 1200 a las abrazaderas del panel 850.

Préparation du plafond et accrochage du Concept :

Preparing the ceiling and hanging the Concept :

Preparando el techo y colgando el Concept :

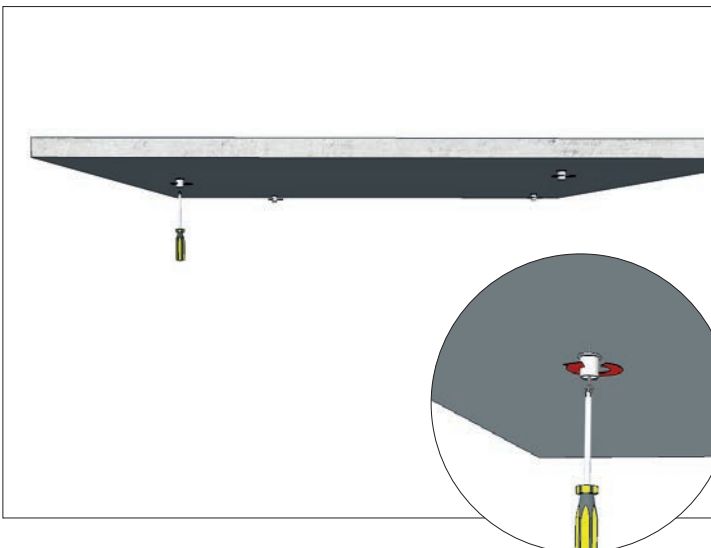

Repérer le placement des élingues, choisir la qualité de la cheville et des vis, puis fixer les embouts.

Mark the placement of the slings, choose the quality of the dowel and the screws, then fix the ends.

Marque la ubicación de las eslingas, elija la calidad de la espiga y los tornillos, luego fije los extremos.

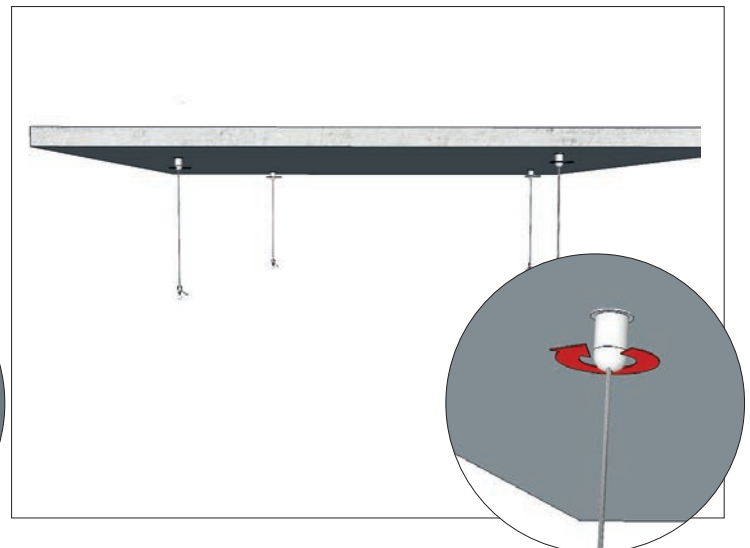

Visser les élingues aux embouts.

Screw the slings to the ends.

Atornille las eslingas hasta los extremos.

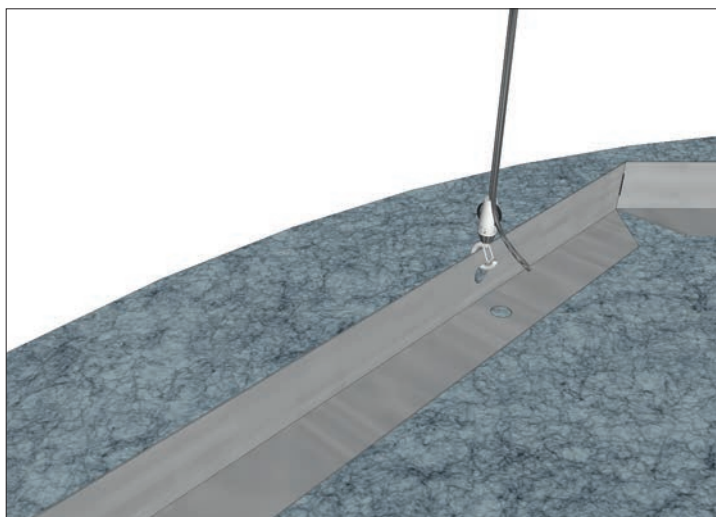

Accrocher le concept aux élingues.
[Hanging concept on slings.](#)
Colgar el concepto en eslingas.

A l'aide d'un niveau, régler la hauteur du concept.
[Using a level, adjust the height of the concept.](#)
Usando un nivel, ajuste la altura del concepto.

texdecor

Collection Coleccion : SlimDeco - Concept Concepto R - 3 panneaux panels paneles

Date de parution - Release date - Fecha de parution : Janvier - January - Enero 2022

siège social
2 rue d'hem - 59780 Willems - France
tel +33 (0)3 20 61 78 37 / Fax +33 (0)3 20 61 75 64

www.texdecor.com

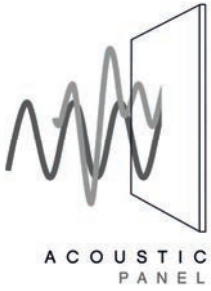

INSTRUCTIONS - INSTRUCCIONES
SlimDeco Erable Maple Arce
Luminaire - Lamp - Làmpara
Plafond - Ceiling - Techo

Doc.Multi.
SLD.NdP.
Erab.P.V2

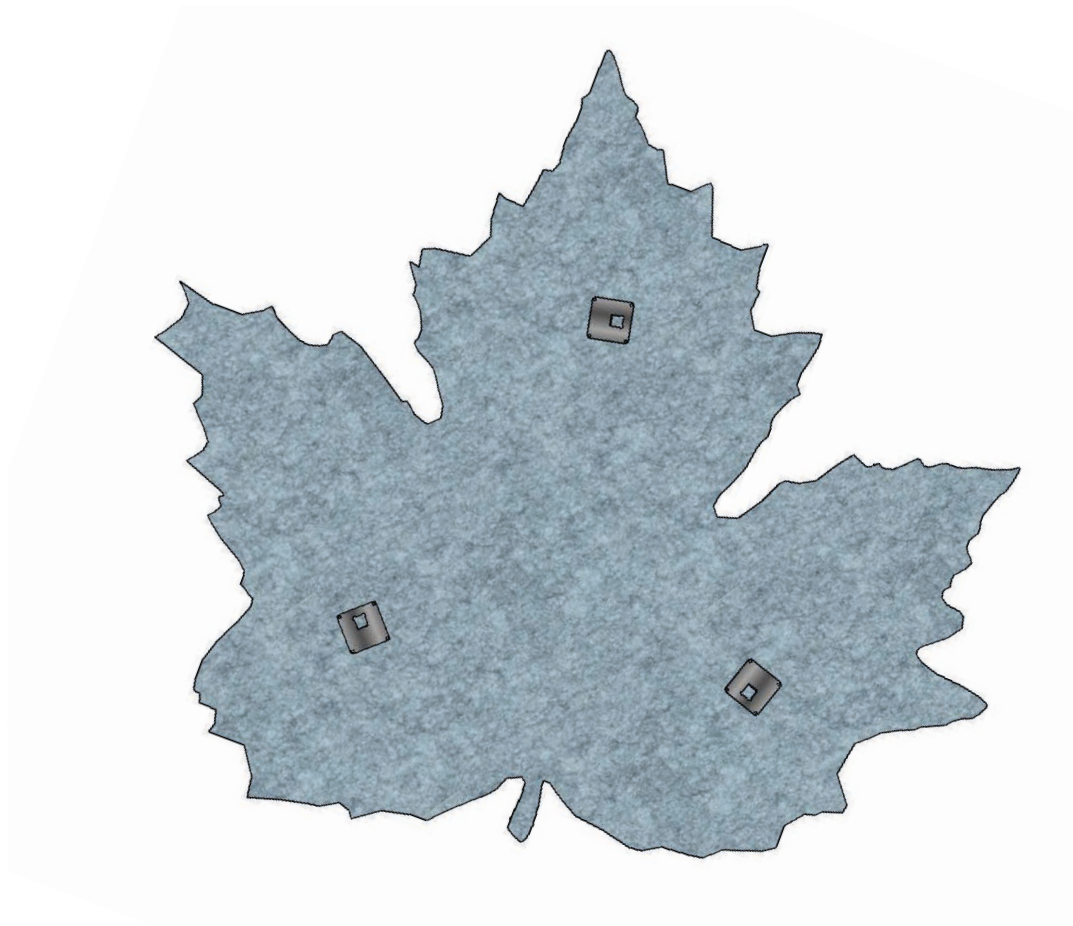
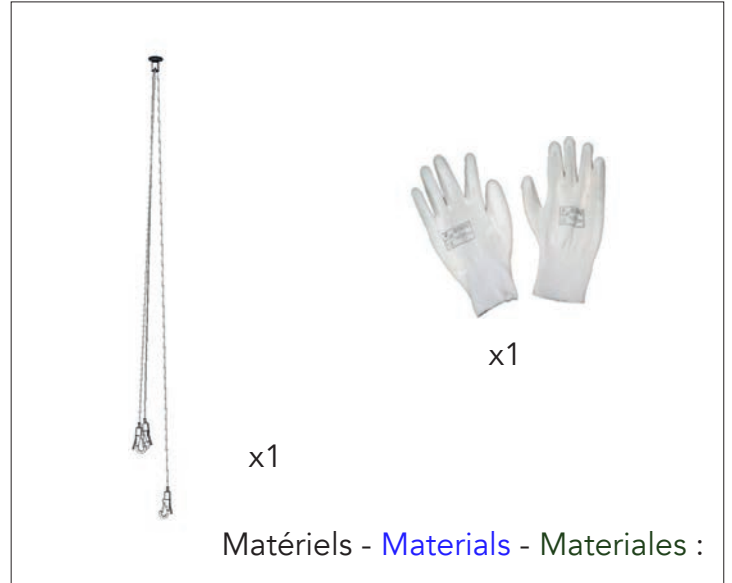

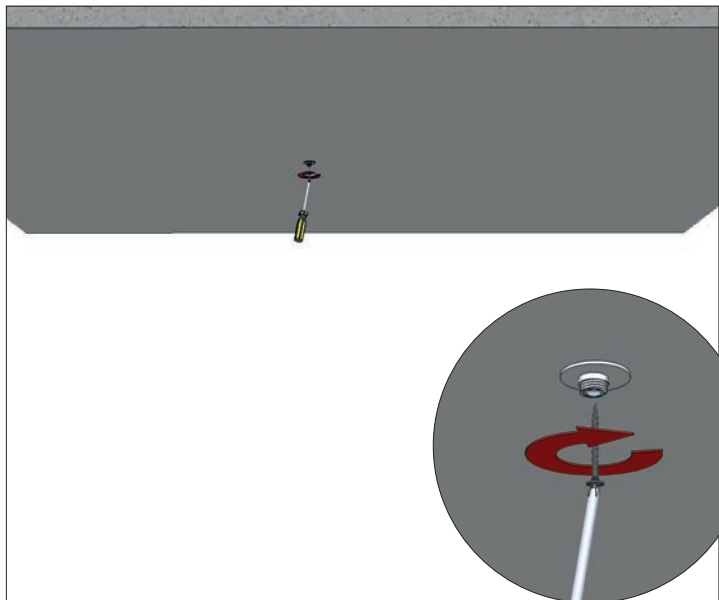

Repérer le placement de l'élingue, choisir la qualité de la cheville et de la vis selon le support, puis fixer l'embout.

Mark the placement of the sling, choose the quality of the plug and the screw according to the support, then fix the end piece.

Marcar la colocación de la eslinga, elegir la calidad del taco y del tornillo según el soporte, luego fije la pieza final.

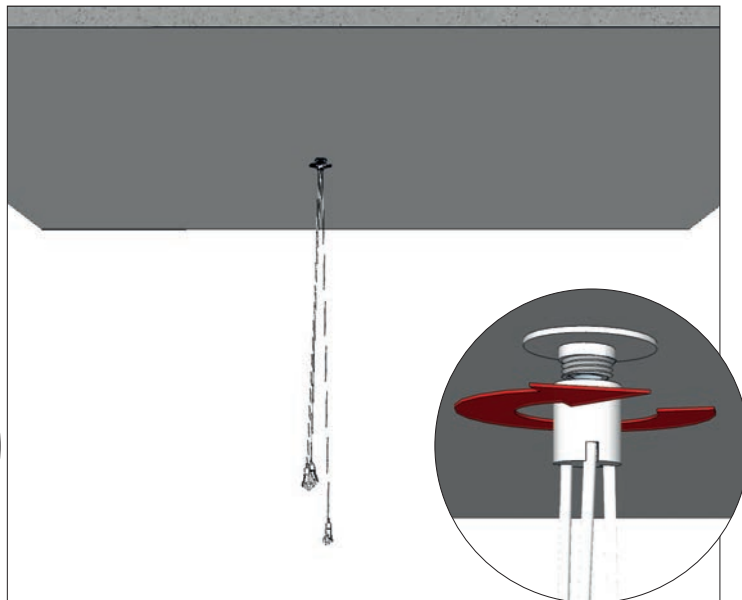

Visser l'élingue à l'embout.

Screw the sling to the end.

Atornille la eslinga hasta el final.

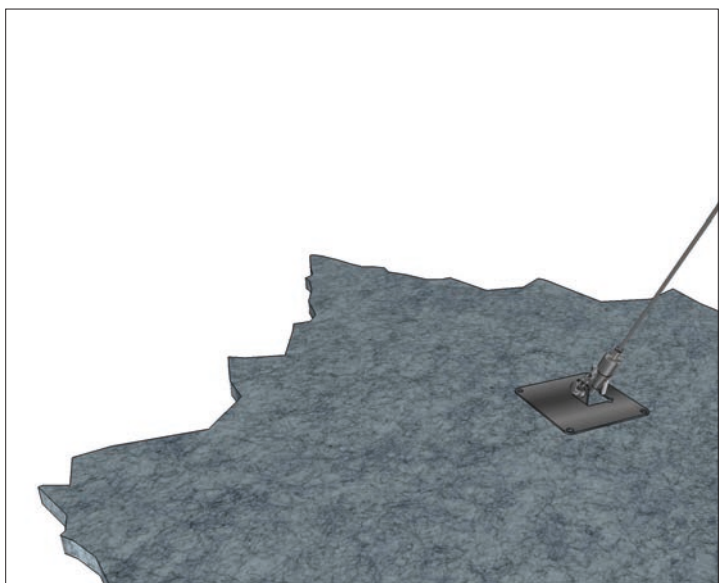

Suspendre le panneau aux crochets de l'élingue.

Suspend the panel from the sling hooks.

Cuelgue el panel de los ganchos de la eslinga.

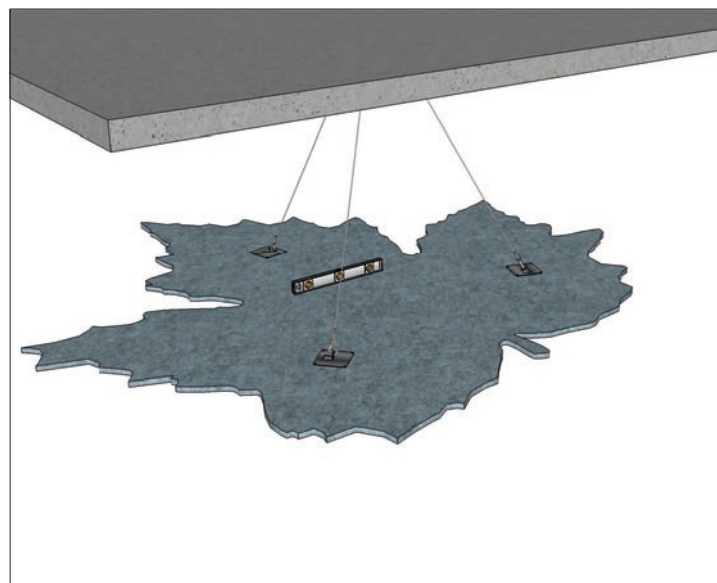

À l'aide d'un niveau, régler la hauteur et l'inclinaison du panneau à convenance.

Using a level, adjust the height and inclination of the panel as required.

Usando un nivel, ajuste la altura y la inclinación del panel según sea necesario.

texdecor

Collection - Colección : SlimDeco - Erable Maple Arce / Plafond-Ceiling -Techo /

Luminaire - Lamp - Làmpara

Date de parution - Release date - Fecha de parution : Janvier - January - Enero 2022

2 rue d'hem - 59780 Willems - France
tel +33 (0)3 20 61 78 37 / Fax +33 (0)3 20 61 75 64

www.texdecor.com

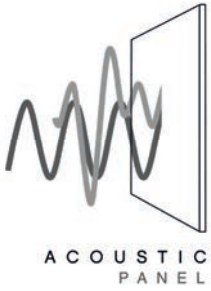

INSTRUCTIONS - INSTRUCCIONES
SlimDeco
Philodendron - Filodendron
Mural - Wall - Pared

Doc.Multi.
SLD.
NdP.Philo.
Mur.SO.V1

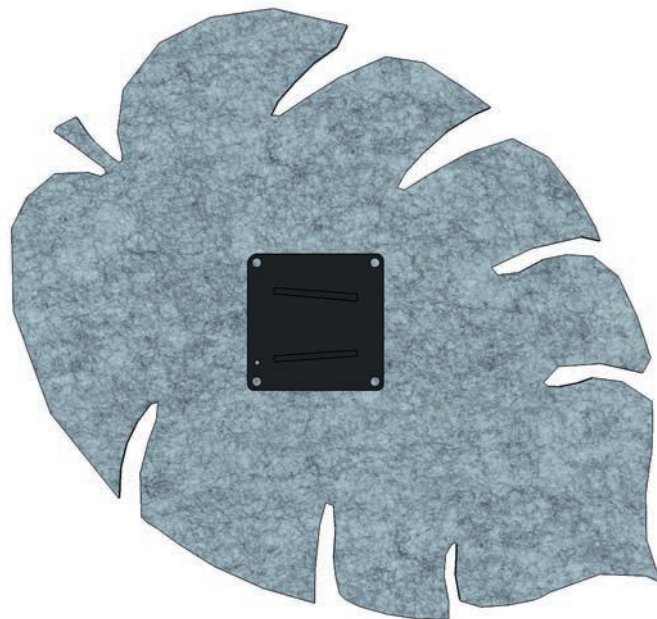
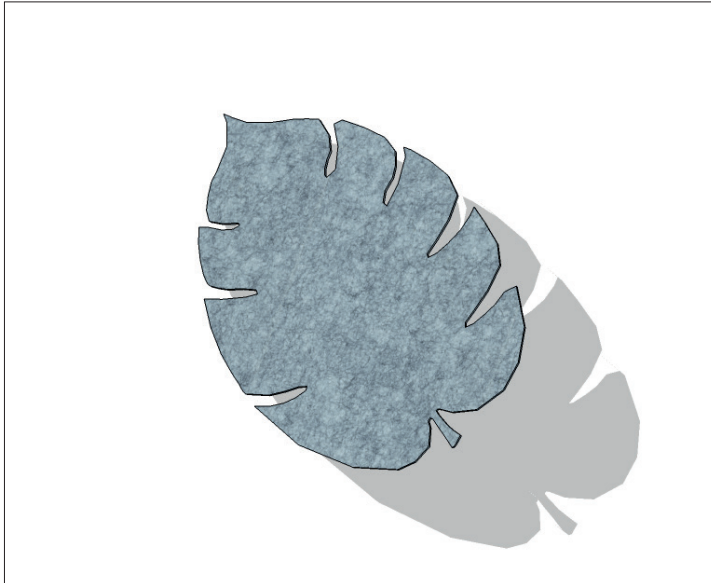

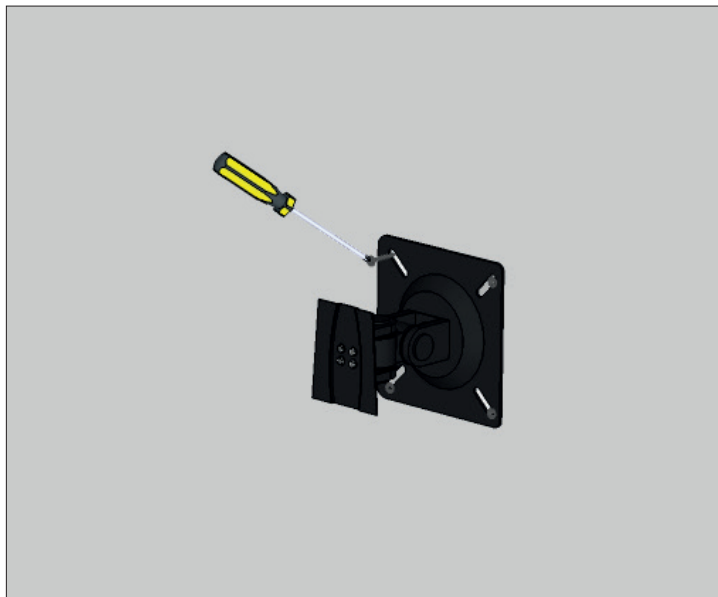

Repérer le placement des vis, choisir la qualité des chevilles et des vis selon le mur, puis fixer le support orientable.

Mark the placement of the screws, choose the quality of the plugs and screws according to the wall, then fix the adjustable support.

Marque la ubicación de los tornillos, elija la calidad de los tacos y tornillos de acuerdo con la pared, luego fije el soporte ajustable.

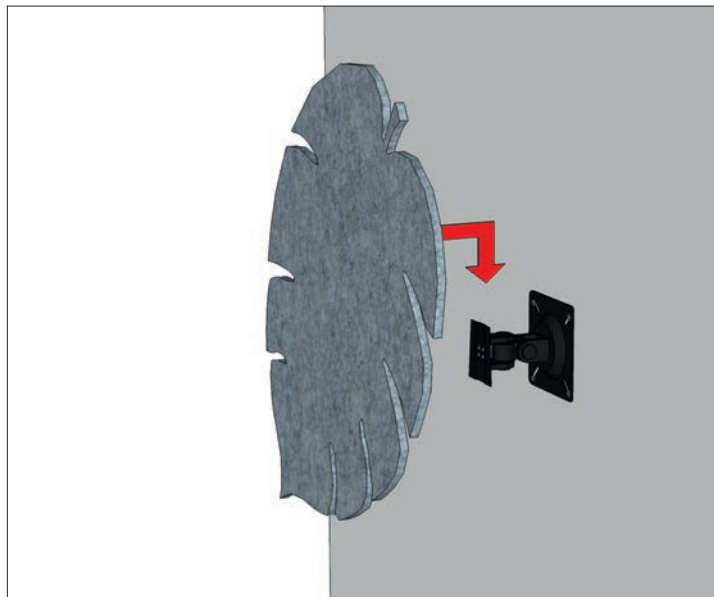

Glisser le panneau dans l'encoche du support orientable.
Slide the panel into the notch of the adjustable support.
Deslice el panel en la muesca del soporte ajustable.

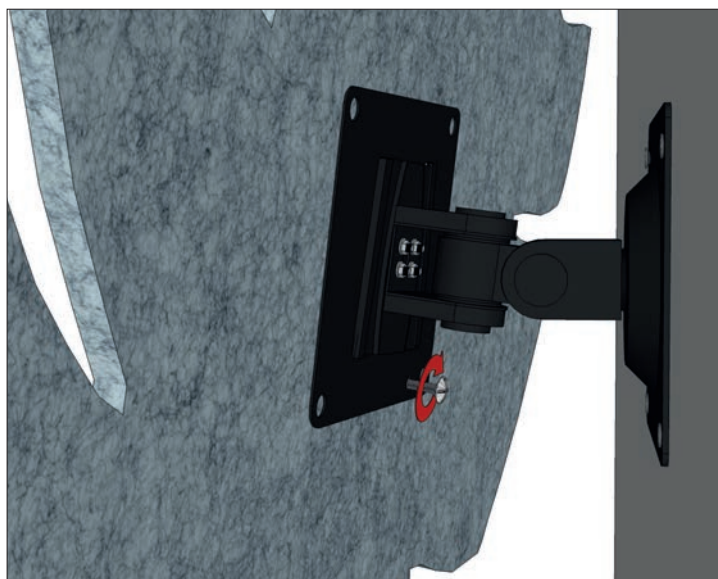

Placer la vis de butée.

Place the stop screw.

Coloque el tornillo de tope.

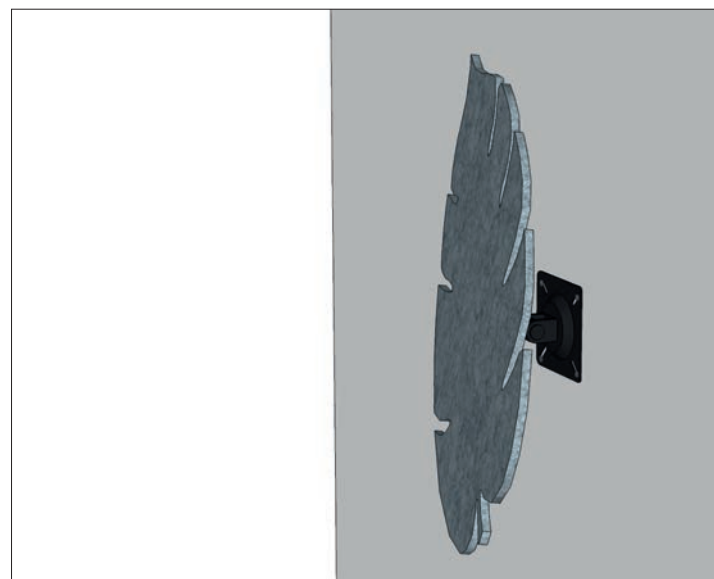

Régler l'inclinaison du panneau.

Adjust the inclination of the panel.

Ajuste la inclinación del panel.

texdecor

Collection : SlimDeco - Philodendron Filodendron / Mural - Wall - Pared

Date de parution - Release date - Fecha de parution : Janvier - January - Enero 2022

2 rue d'hem - 59780 Willems - France
tel +33 (0)3 20 61 78 37 / Fax +33 (0)3 20 61 75 64

www.texdecor.com

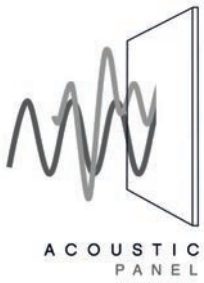

INSTRUCTIONS - INSTRUCCIONES
SlimDeco
Philodendron M- Filodendron
Luminaire - Lamp - L mpara
Plafond - Ceiling - Techo

Doc.Multi.
SLD.
NdP.Phil.M
Lum.P.V2

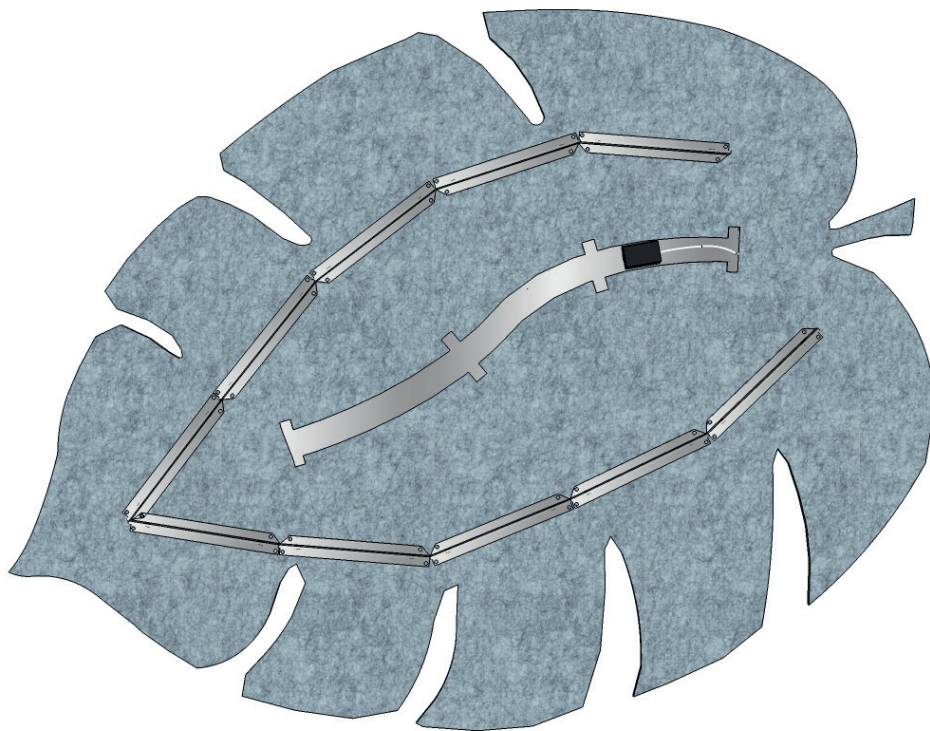

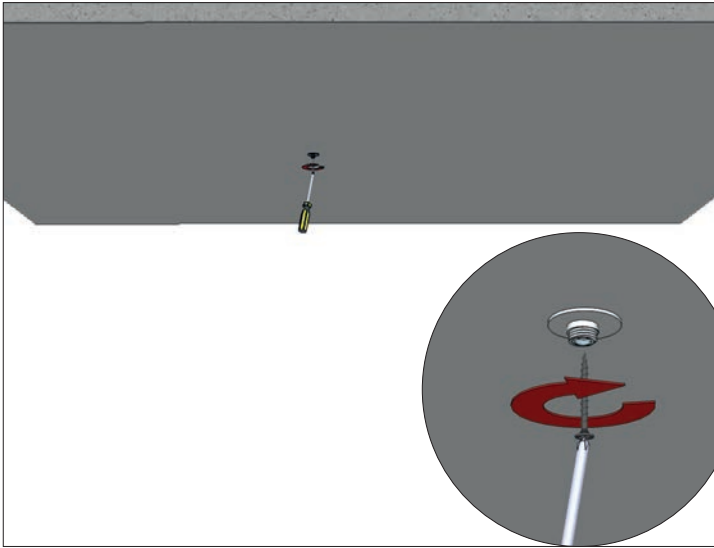

Repérer le placement de l'élingue, choisir la qualité de la cheville et de la vis selon le support, puis fixer l'embout.

Mark the placement of the sling, choose the quality of the plug and the screw according to the support, then fix the end piece.

Marcar la colocación de la eslinga, elegir la calidad del taco y del tornillo según el soporte, luego fije la pieza final.

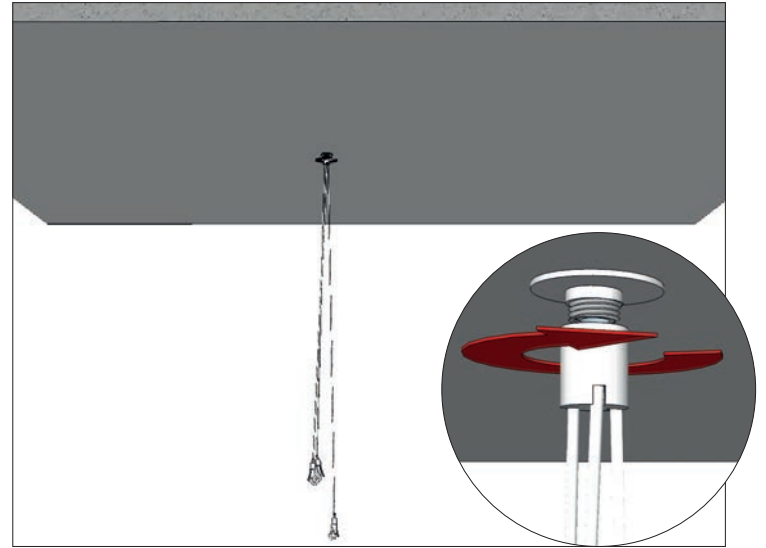

Visser l'élingue à l'embout.

Screw the sling to the end.

Atornille la eslinga hasta el final.



Réaliser le câblage.

Carry out the wiring.

Realizar el cableado.

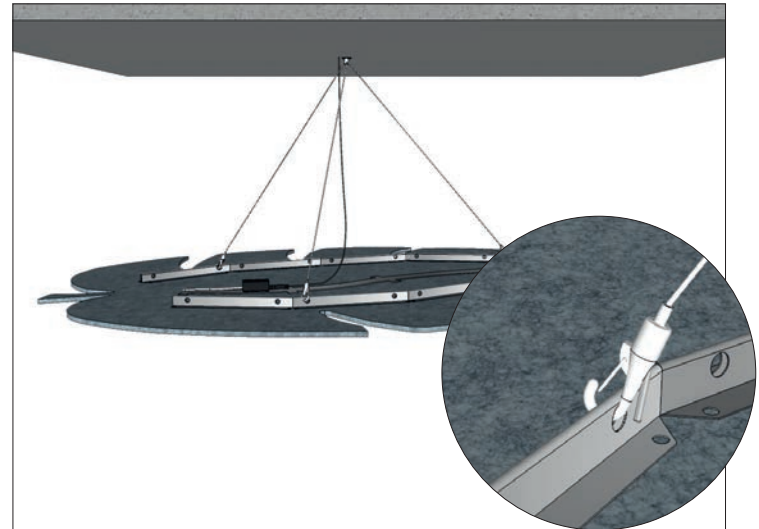

Suspendre le panneau aux crochets de l'élingue.

Suspend the panel from the sling hooks.

Cuelgue el panel de los ganchos de la eslinga.

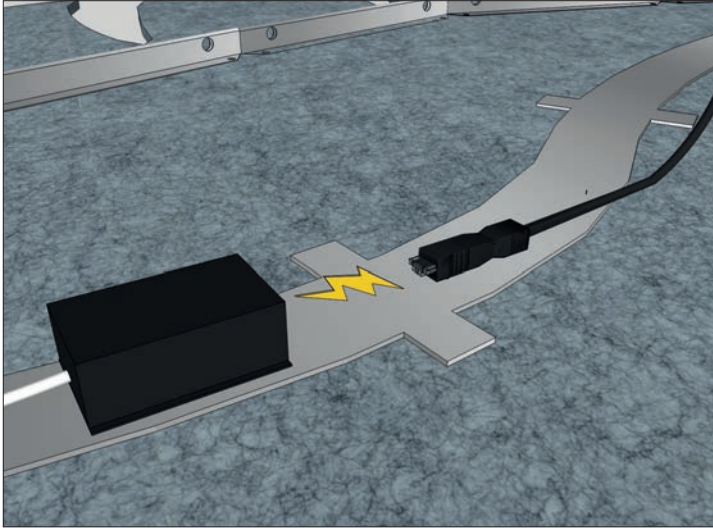

Brancher les connecteurs entre eux.
[Connect the connectors together.](#)
Conecte los conectores juntos.

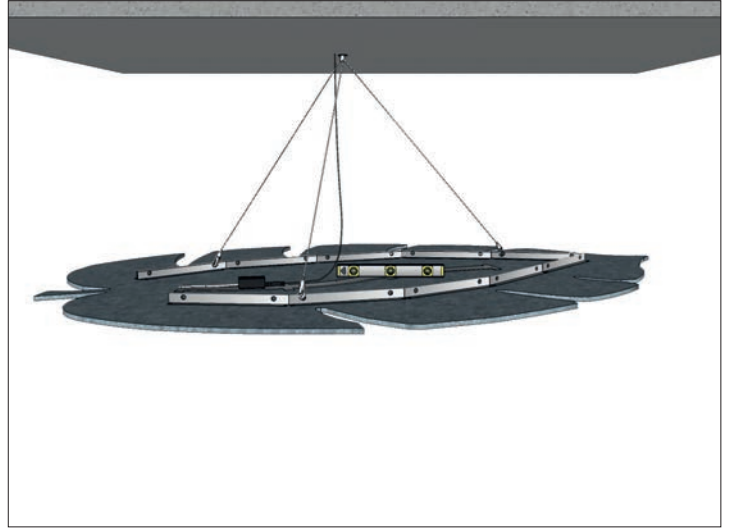

À l'aide d'un niveau, régler la hauteur et l'inclinaison du panneau à convenance.
[Using a level, adjust the height and inclination of the panel as required.](#)
Usando un nivel, ajuste la altura y la inclinación del panel según sea necesario.

texdecor

Collection - Colección : SlimDeco - Philodendron Filofendron / Plafond-Ceiling -
Techo / Luminaire - Lamp - L'àmpara

Date de parution - Release date - Fecha de parution : Janvier - January - Enero 2022

2 rue d'hem - 59780 Willems - France
tel +33 (0)3 20 61 78 37 / Fax +33 (0)3 20 61 75 64

www.texdecor.com

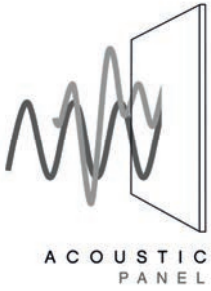

INSTRUCTIONS- INSTRUCCIONES

SlimDeco

Philodendron M- Filodendron

Plafond - Ceiling - Techo

Doc.Multi.
SLD.NdP.M
Phil.P.V2

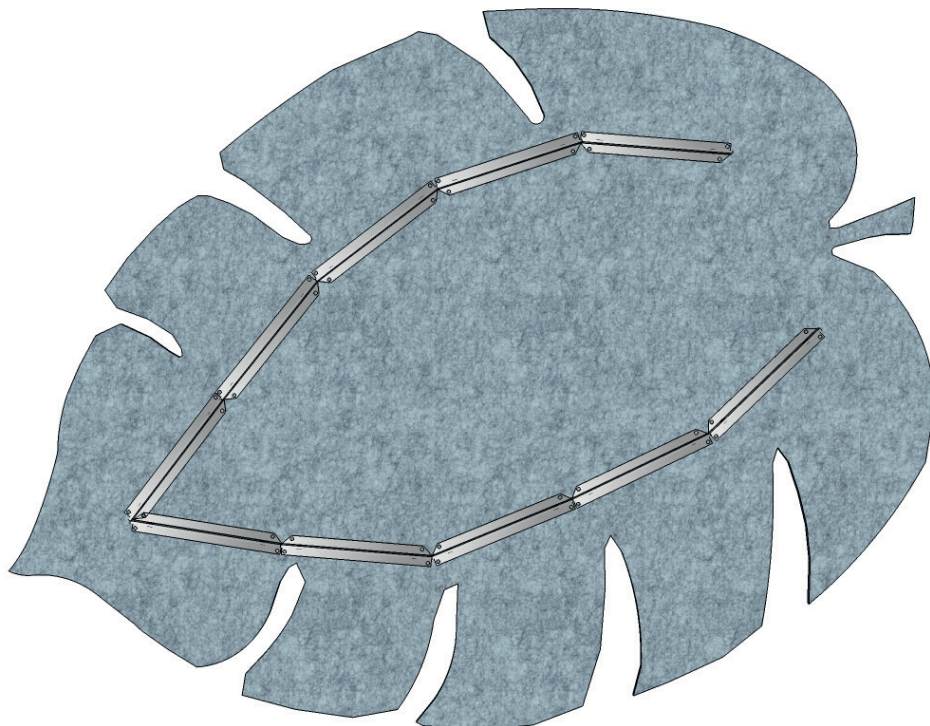
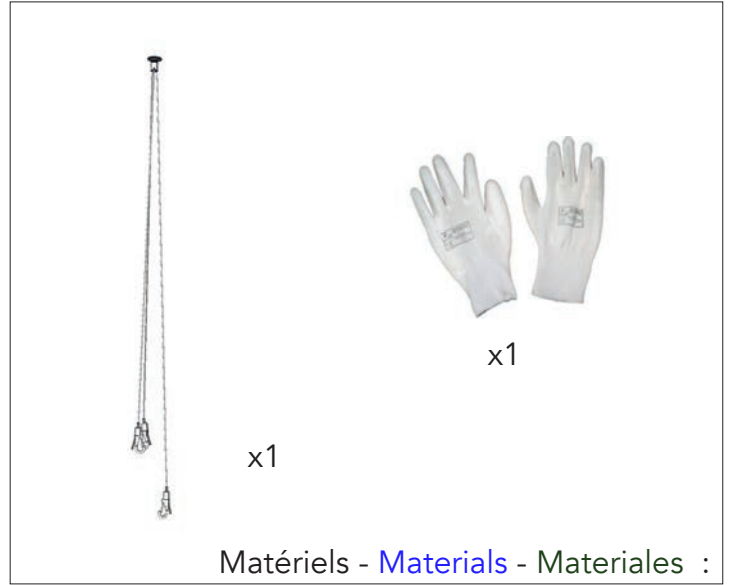
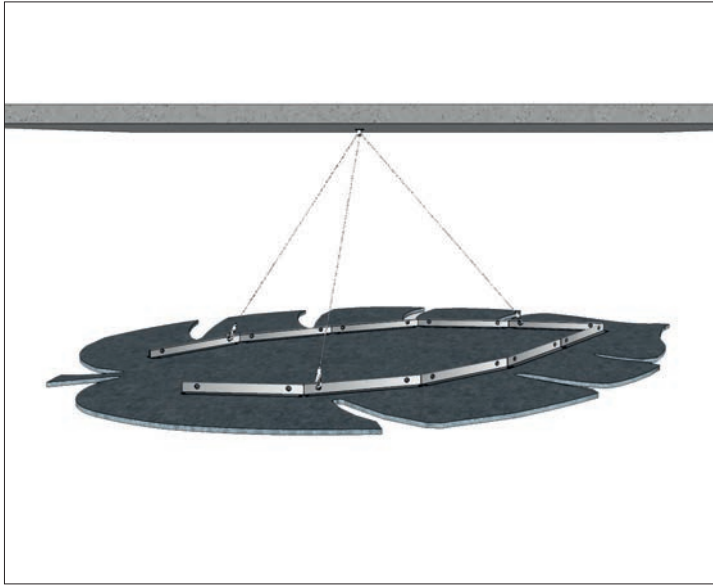

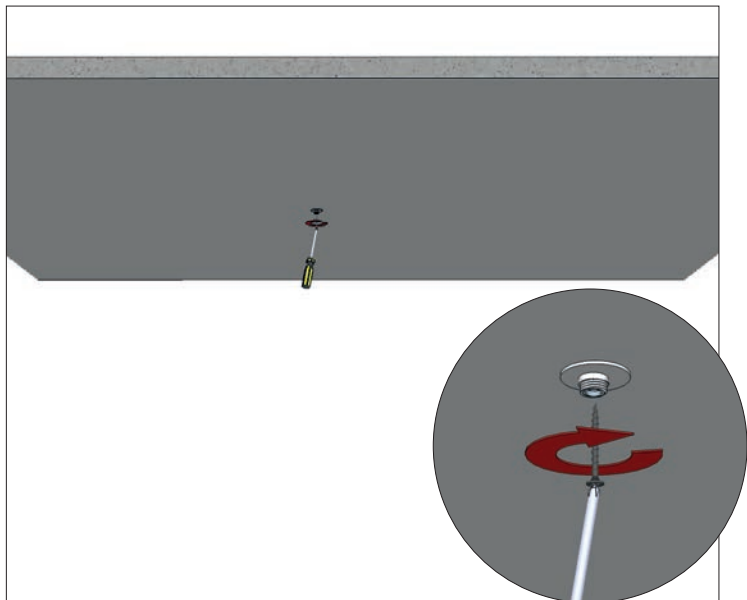

Repérer le placement de l'élingue, choisir la qualité de la cheville et de la vis selon le support, puis fixer l'embout.

Mark the placement of the sling, choose the quality of the plug and the screw according to the support, then fix the end piece.

Marcar la colocación de la eslinga, elegir la calidad del taco y del tornillo según el soporte, luego fije la pieza final.

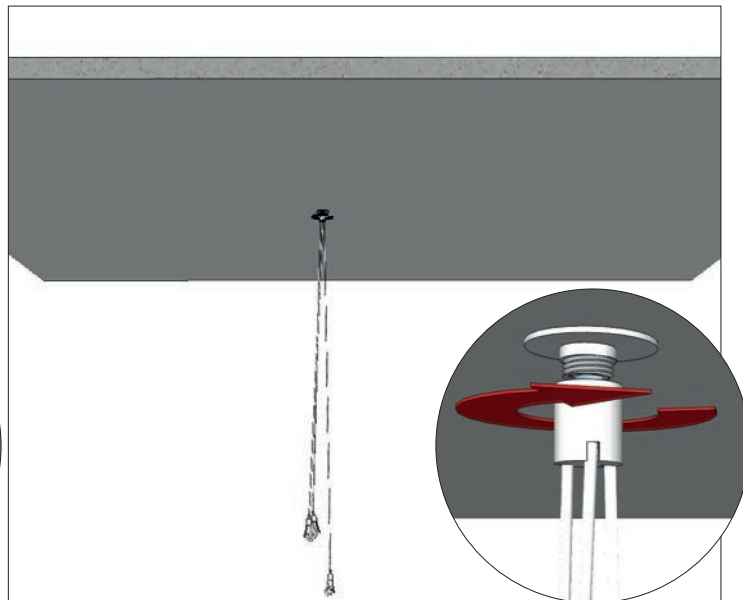

Visser l'élingue à l'embout.

Screw the sling to the end.

Atornille la eslinga hasta el final.

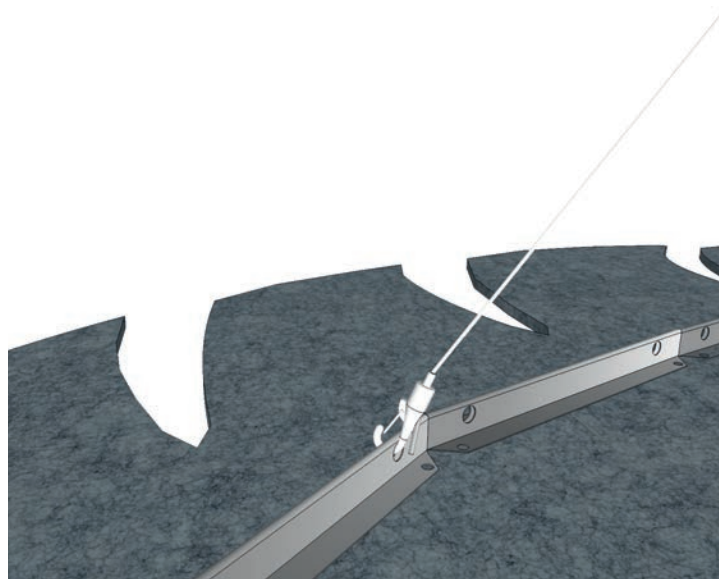

Suspendre le panneau aux crochets de l'élingue.

Suspend the panel from the sling hooks.

Cuelgue el panel de los ganchos de la eslinga.



À l'aide d'un niveau, régler la hauteur et l'inclinaison du panneau à convenance.

Using a level, adjust the height and inclination of the panel as required.

Usando un nivel, ajuste la altura y la inclinación del panel según sea necesario.

texdecor

Collection - Colección : SlimDeco - Philodendron Filofendron / Plafond-Ceiling - Techo

Date de parution - Release date - Fecha de parution : Janvier - January - Enero 2022

2 rue d'hem - 59780 Willems - France
tel +33 (0)3 20 61 78 37 / Fax +33 (0)3 20 61 75 64

www.texdecor.com

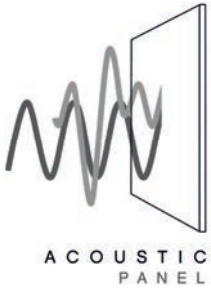

INSTRUCTIONS - INSTRUCCIONES

SlimDeco

Rond-Round-Ronda

Mural-Wall-Pared

Support Orientable-Swivel bracket-
Soporte giratorio

Doc.Multi.
SLD.
NdP.Rond.
Mur.SO.Fr.
V1

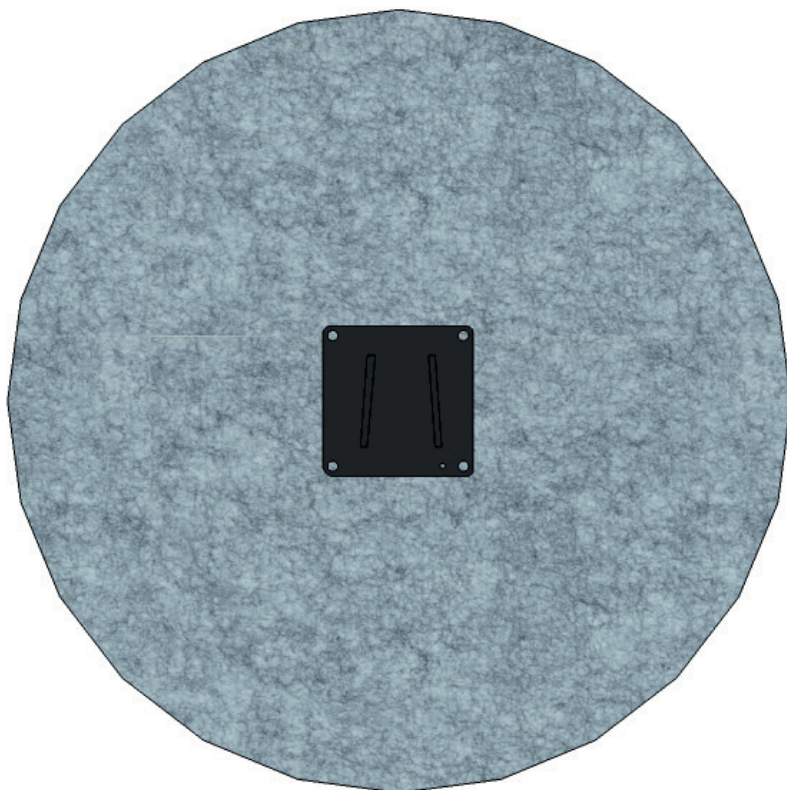
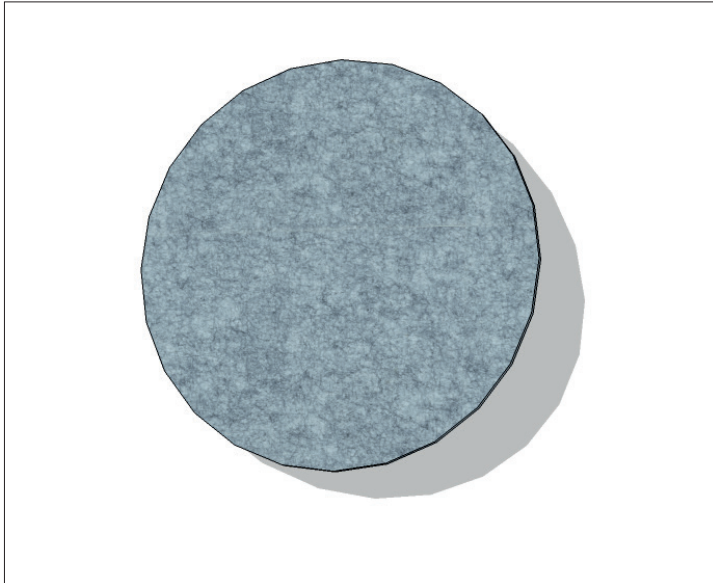

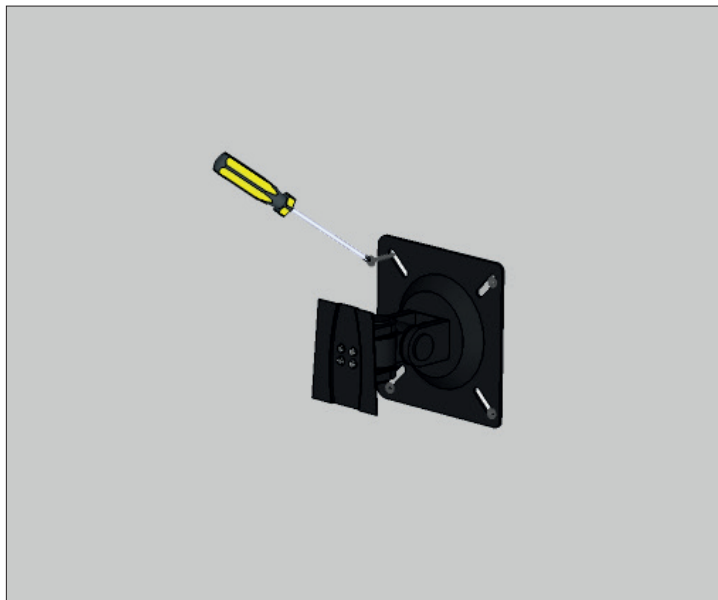

Repérer le placement des vis, choisir la qualité des chevilles et des vis selon le mur, puis fixer le support orientable.

Mark the placement of the screws, choose the quality of the plugs and screws according to the wall, then fix the adjustable support.

Marque la ubicación de los tornillos, elija la calidad de los tacos y tornillos de acuerdo con la pared, luego fije el soporte ajustable.

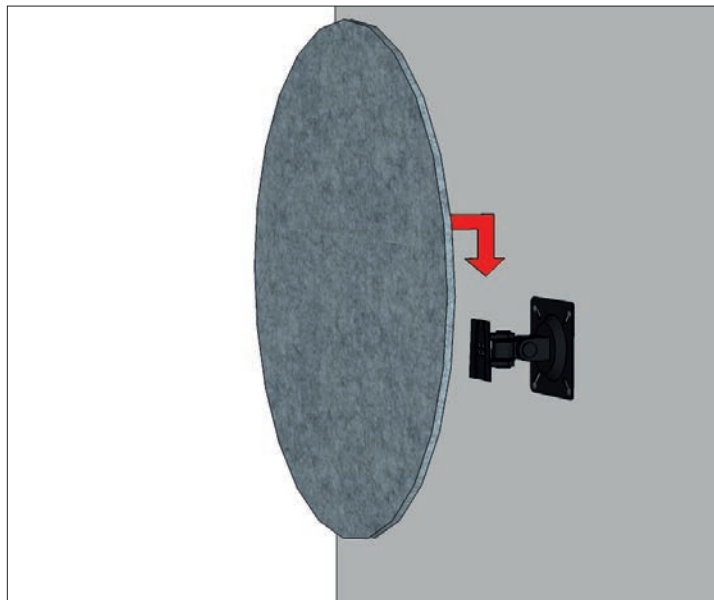

Glisser le panneau dans l'encoche du support orientable.
Slide the panel into the notch of the adjustable support.
Deslice el panel en la muesca del soporte ajustable.

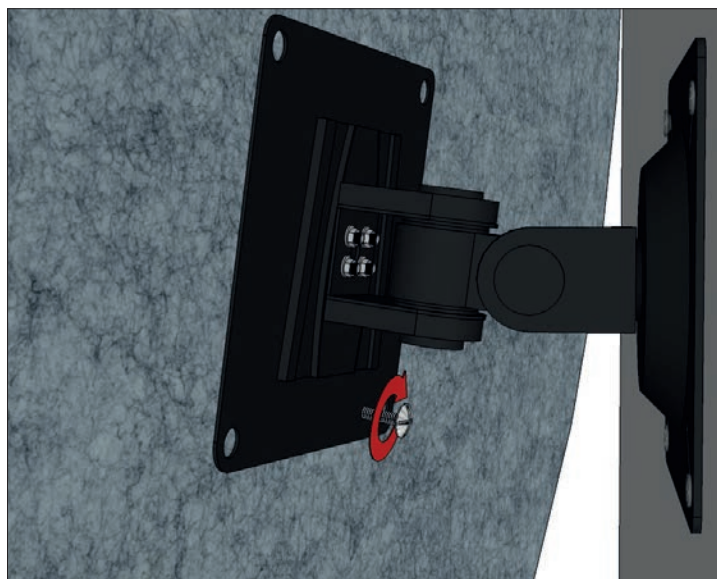

Placer la vis de butée.

Place the stop screw.

Coloque el tornillo de tope.

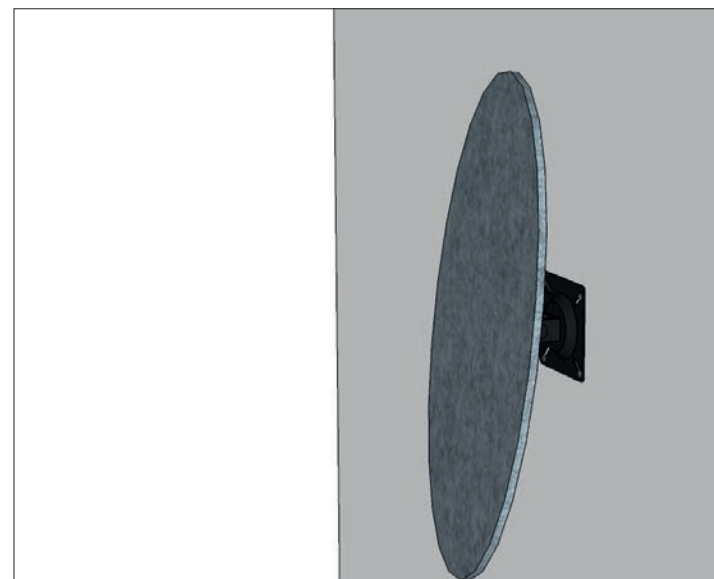

Régler l'inclinaison du panneau.

Adjust the inclination of the panel.

Ajuste la inclinación del panel.

texdecor

Collection : SlimDeco - Rond Round Ronda / Mural Wall Pared - Support Orientable
Swivel bracket Soporte giratorio

Date de parution - Release date - Fecha de parution : Janvier - January - Enero 2022

2 rue d'hem - 59780 Willems - France
tel +33 (0)3 20 61 78 37 / Fax +33 (0)3 20 61 75 64

www.texdecor.com

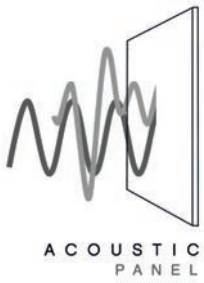

INSTRUCTIONS INSTRUCCIONES

SlimDeco

Rond Round Ronda1200

Rails Tracks Pistas
Mural Wall Pared

Doc.Multi.
SLD.
NdP.Rond.
1200.Mur.
Rails

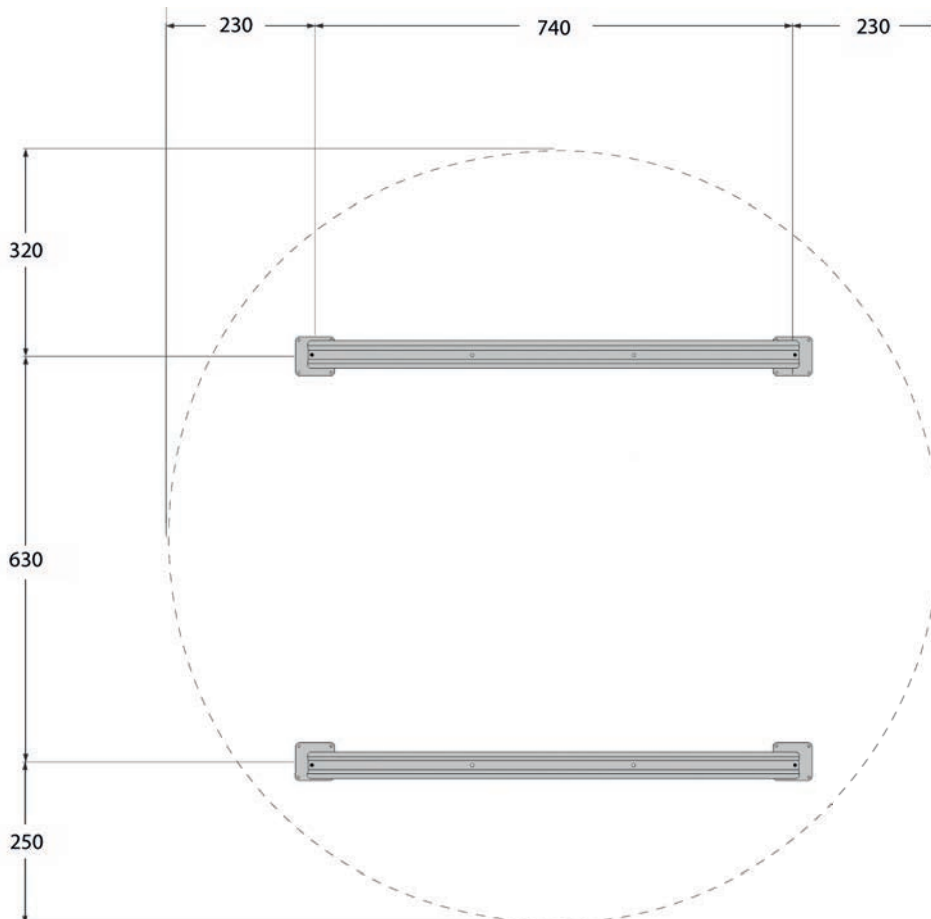
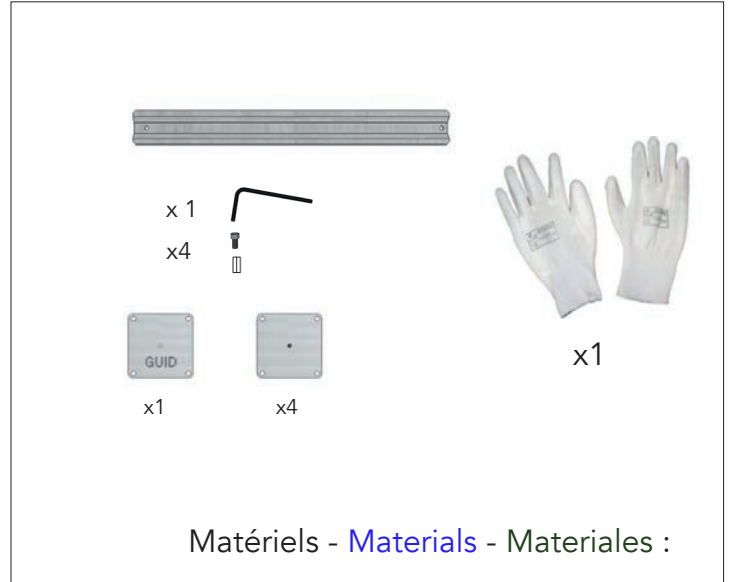
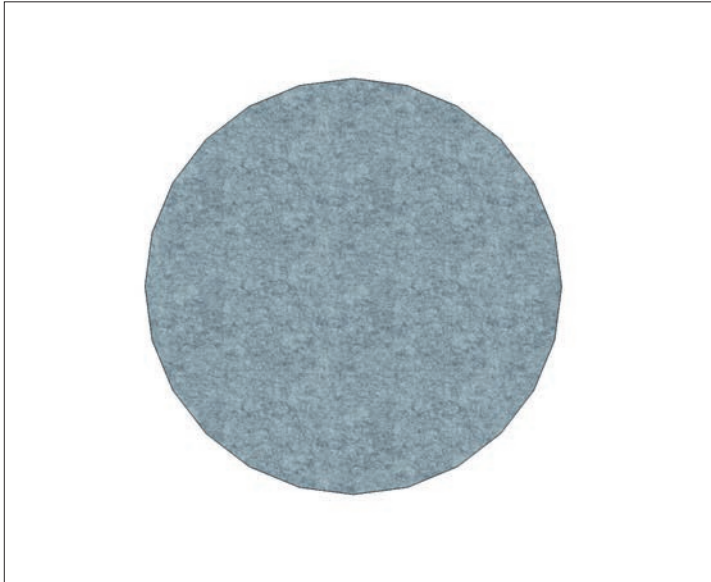

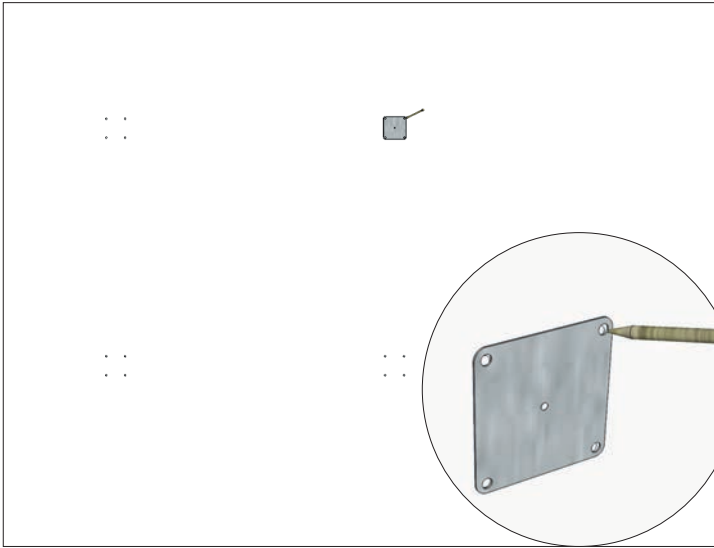

Definir l'emplacement du panneau final. Puis repérer les 4 pa-tères. A l'aide du gabarit marquer le placement des vis.
Define the location of the final panel. Then locate the 4 pegs. Using the template, mark the placement of the screws.
 Definir la ubicación del panel final. Luego ubique las 4 clavijas. Usando la plantilla, marque la ubicación de los tornillos.

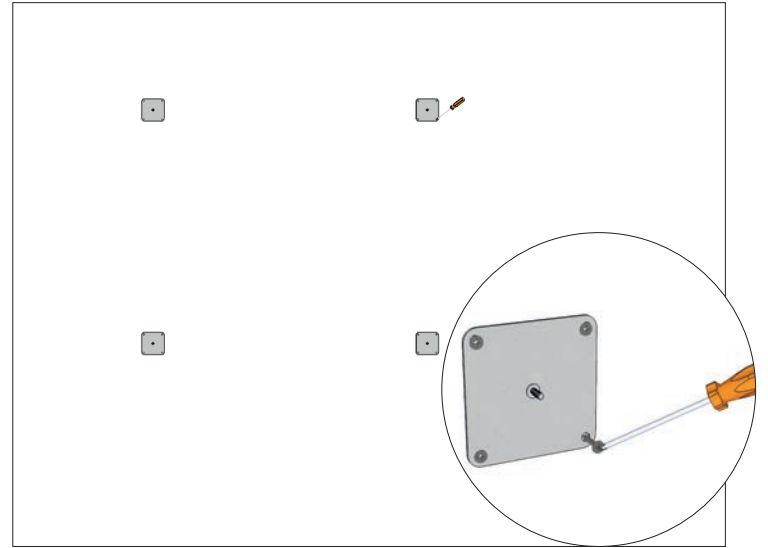

Installer les 4 patères.
Install the 4 pegs.
 Instale las 4 clavijas.

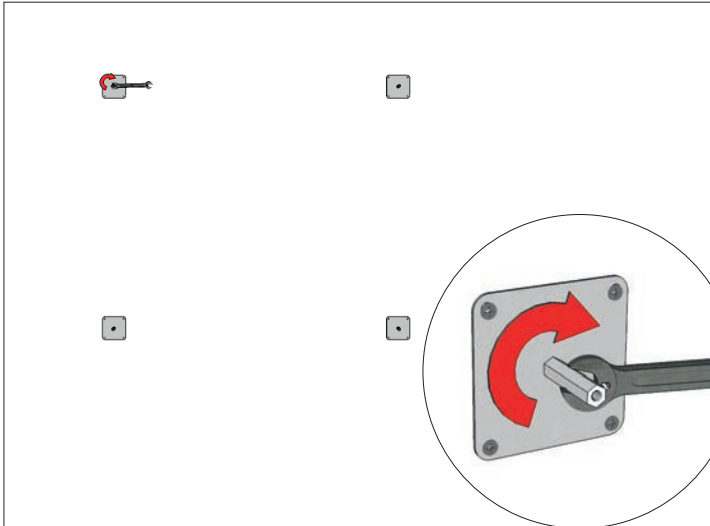

Installer les entretoises.
Install spacers.
 Instale espaciadores.

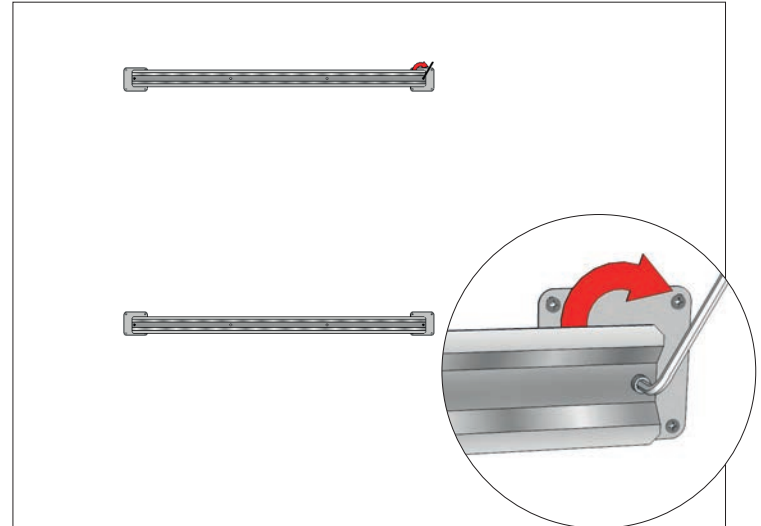

Fixer les rails avec les vis BTR.
Fix the rails with BTR screws.
 Fije los rieles con tornillos BTR.

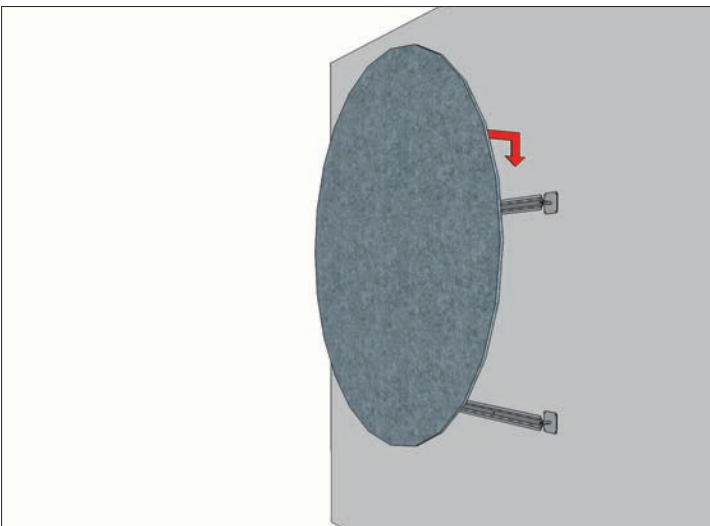

Installer le panneau.
Install the panel.
 Instale el panel.

texdecor

Collection : SlimDeco - Rond Round Ronda 1200 Mural Wall Pared - Rails Tracks Pistas

Date de parution - Release date - Fecha de parution : Janvier - January - Enero 2022

2 rue d'hem - 59780 Willems - France
 tel +33 (0)3 20 61 78 37 / Fax +33 (0)3 20 61 75 64

www.texdecor.com