

## FIXATION AU PLAFOND SUR RAIL MÉTALLIQUE

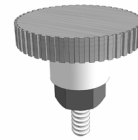

## FOURNITURES LIVRÉES



X 4



X 1

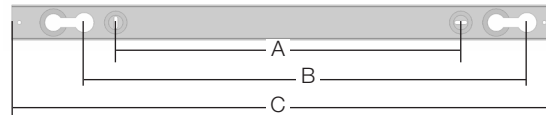

X 2

Rail	A	B	C
1200	963,6	1067,1	1170
600	363,6	467,1	570
300	-	167,1	270

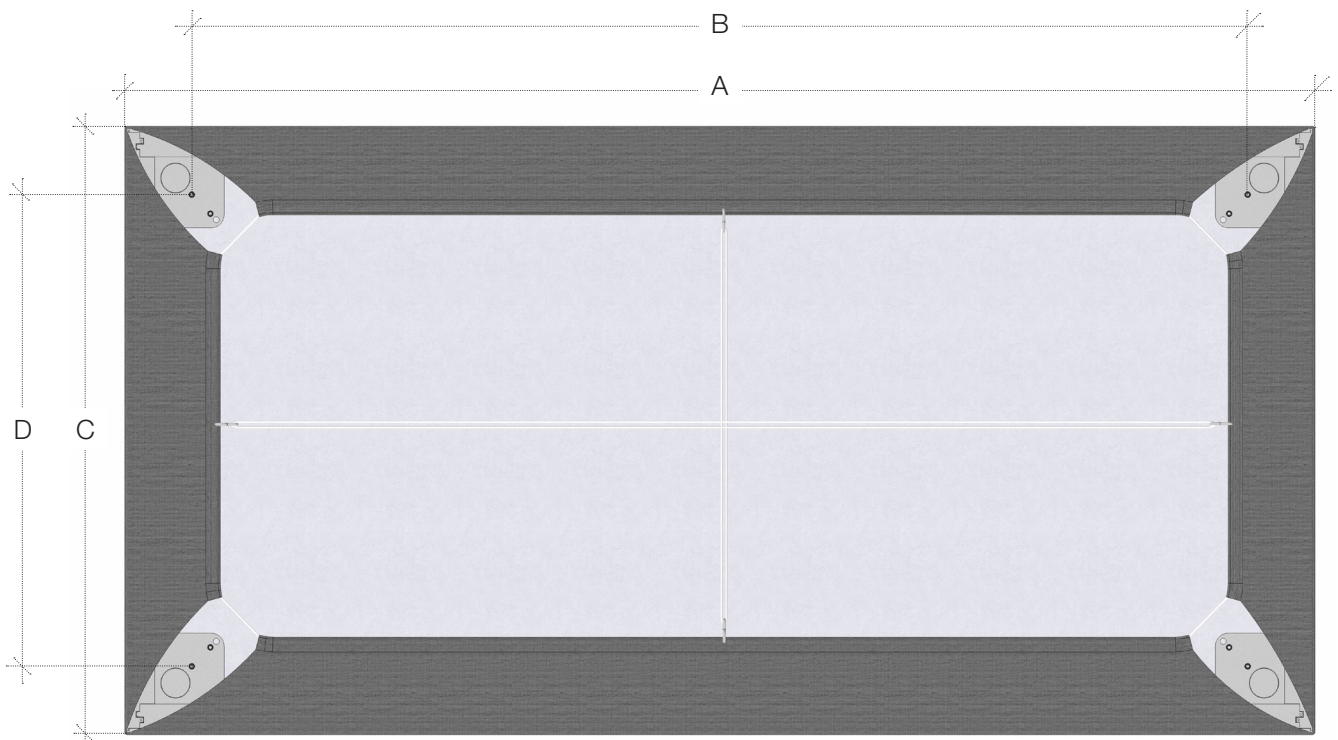

Exemple d'illustration du panneau 1200 x 600

Panneau	A	B	C	D	
1200 x 1200	1200 (mm)	1068	1200	1068	8,5 kg
1200 x 600	1200	1068	600	468	4,25 kg
1200 x 300	1200	1068	300	168	3,87 kg
600 x 600	600	468	600	468	3,87 kg
600 x 300	600	468	300	168	1,96 kg
600 x 2400	2400	2270,5	600	468	9,7 kg
600 x 1800	1800	1669,5	600	468	6,37 kg
1800 x 300	1800	1669,5	300	168	4,25 kg
2400 x 300	2400	2269,5	300	168	5,30 kg
2400 x 1200	2400	2269,5	1200	1068	17 kg

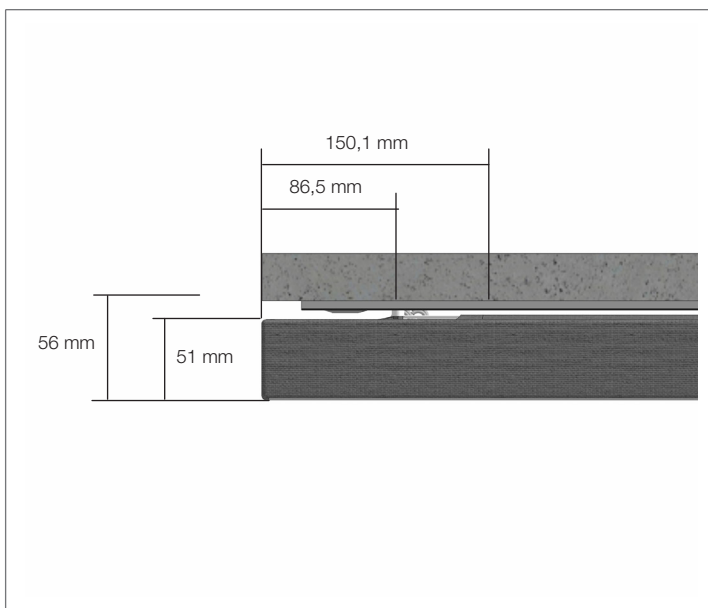
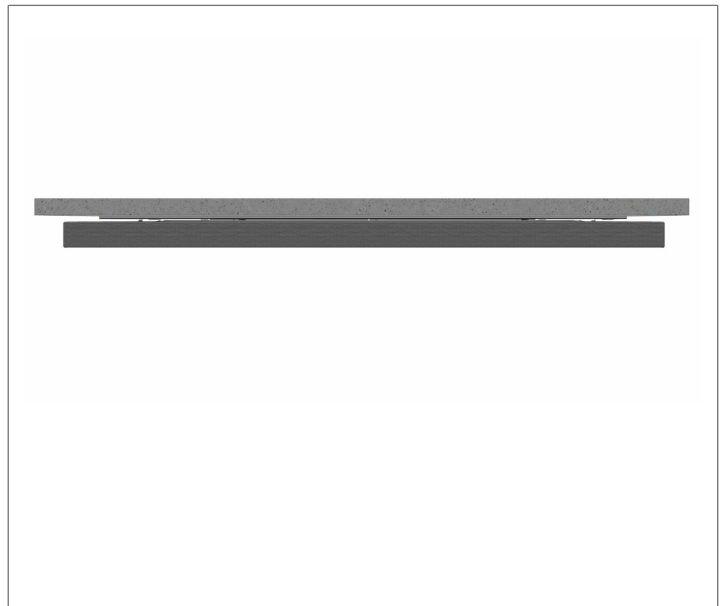
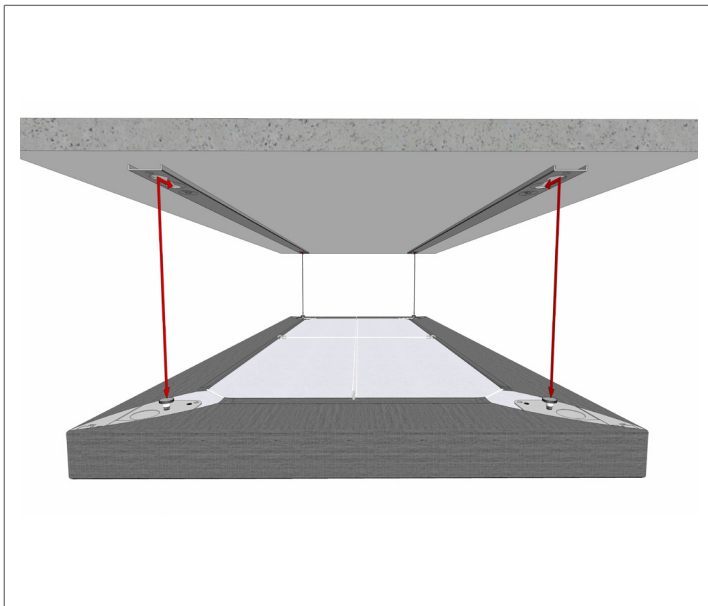
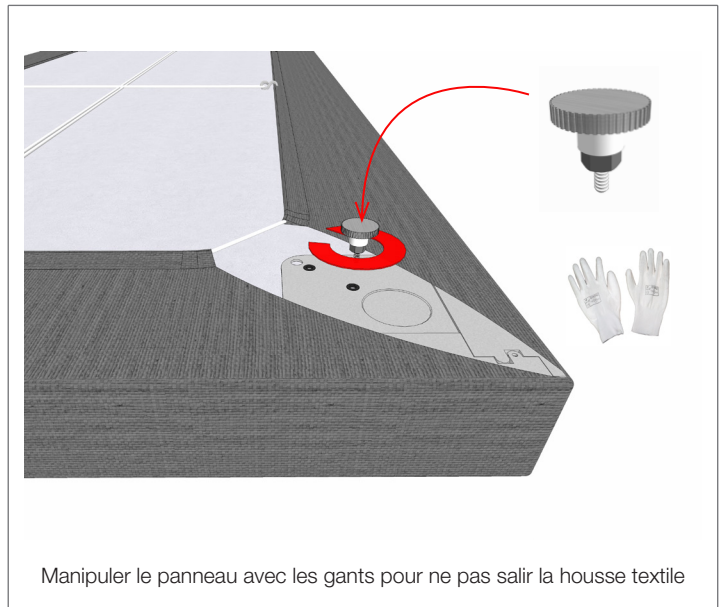
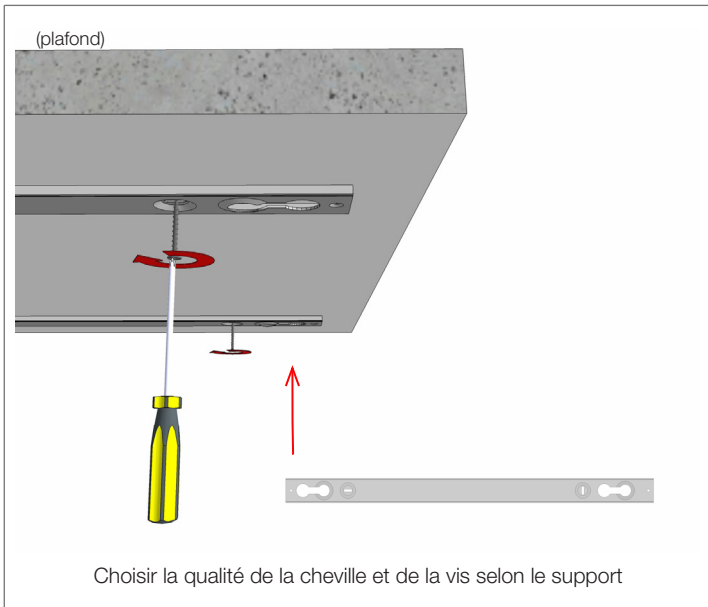

Collection : AirPanel / Gamme Acoustic 0.7  
Date de parution : Février 2017

## FIXATION AU MUR PAR AIMANT

ATTENTION : Ne convient pas au plafond

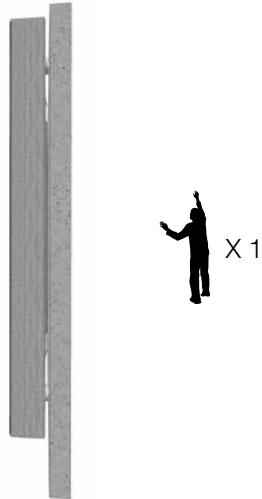

## FOURNITURES LIVRÉES



X 4



X 1



X 4

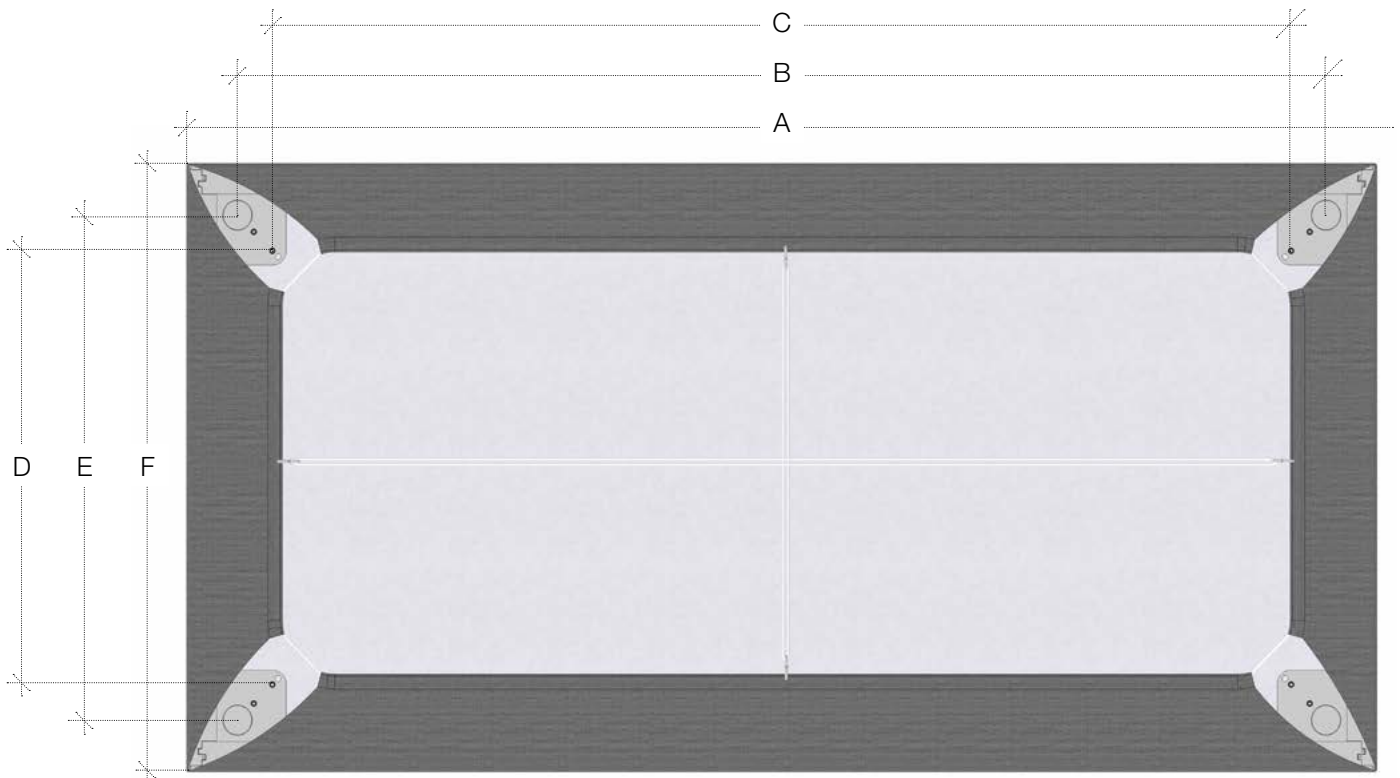

Exemple d'illustration du panneau 1200 x 600

Panneau	A	B	C	D	
1200 x 1200	1200 (mm)	1103	1200	1103	8,5 kg
1200 x 600	1200	1103	600	503	4,25 kg
1200 x 300	1200	1103	300	203	3,87 kg
600 x 600	600	503	600	503	3,87 kg
600 x 300	600	503	300	203	1,96 kg

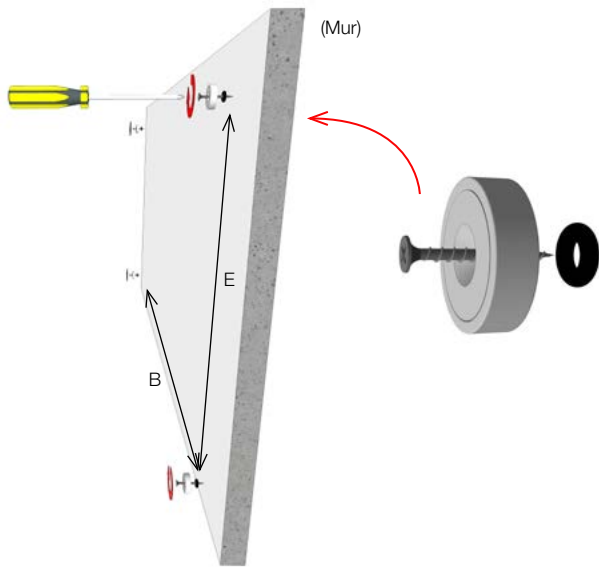

La rondelle caoutchouc permet de corriger les légers défauts de planéité du mur, afin de garantir un contact optimal entre la platine du cadre et l'aimant.

Visser l'aimant en butté, sans écraser la rondelle.

Choisir la qualité de la cheville et de la vis selon le support.



Manipuler le panneau avec les gants pour ne pas salir la housse textile

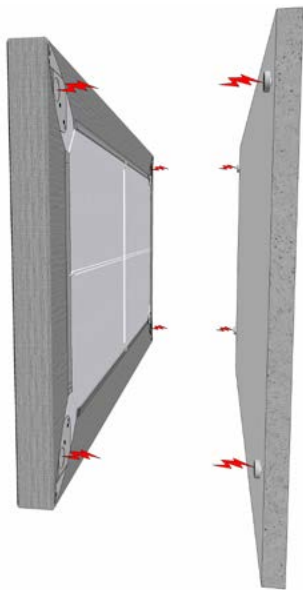

**ATTENTION :** Positionner le cadre de telle sorte que l'aimant soit placé dans la cavité ronde de chaque platine, afin de garantir le maintien latéral optimal du panneau

Collection : AirPanel / Gamme Acoustic 0.7  
Date de parution : Avril 2016

 **texdecor**  
PANEL

siège social – head office  
2 rue d'hem - 59780 Willems - France  
tel +33 (0)3 20 61 78 37 / Fax +33 (0)3 20 61 75 64  
[www.texdecor.fr](http://www.texdecor.fr)

## FIXATION AU MUR SUR RAIL MÉTALLIQUE



## FOURNITURES LIVRÉES

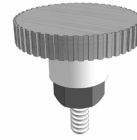

X 4



X 1

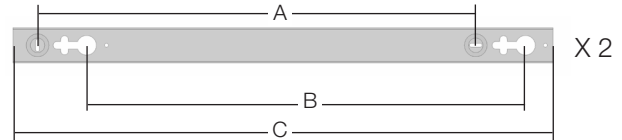

Rail	A	B	C
1200	1064	1067,1	1170
600	464	467,1	570
300	164	167,1	270

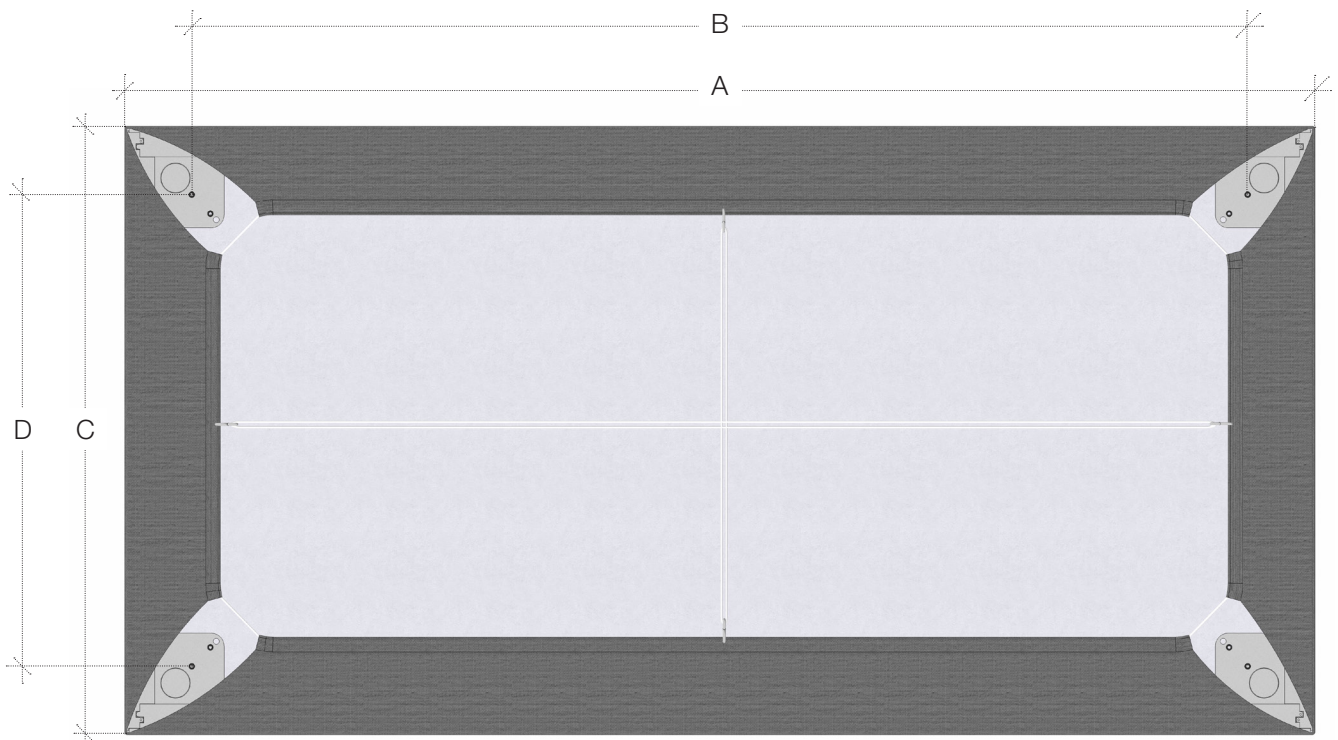

Exemple d'illustration du panneau 1200 x 600

Panneau	A	B	C	D	
1200 x 1200	1200 (mm)	1068	1200	1068	8,5 kg
1200 x 600	1200	1068	600	468	4,25 kg
1200 x 300	1200	1068	300	168	3,87 kg
600 x 600	600	468	600	468	3,87 kg
600 x 300	600	468	300	168	1,96 kg
600 x 2400	2400	2270,5	600	468	9,7 kg
600 x 1800	1800	1669,5	600	468	6,37 kg
1800 x 300	1800	1669,5	300	168	4,25 kg
2400 x 300	2400	2269,5	300	168	5,30 kg
2400 x 1200	2400	2269,5	1200	1068	17 kg

Choisir la qualité de la cheville et de la vis selon le support

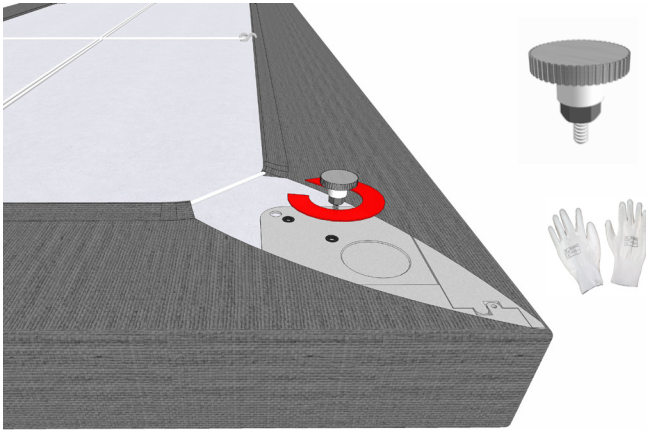
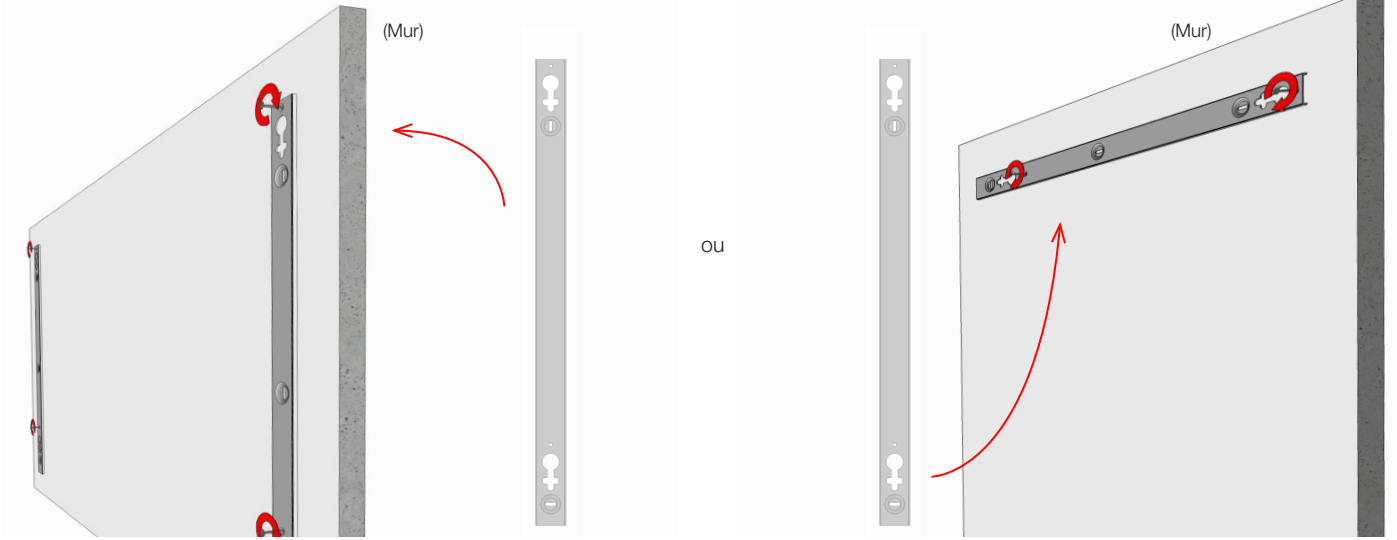

Manipuler le panneau avec les gants pour ne pas salir la housse textile

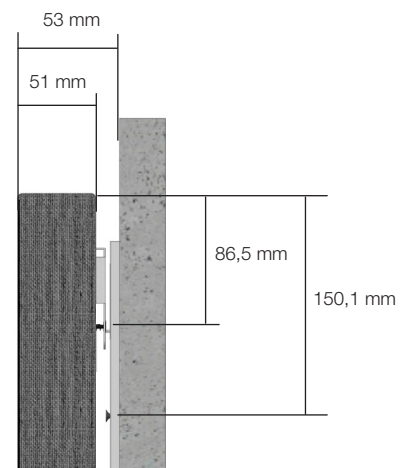
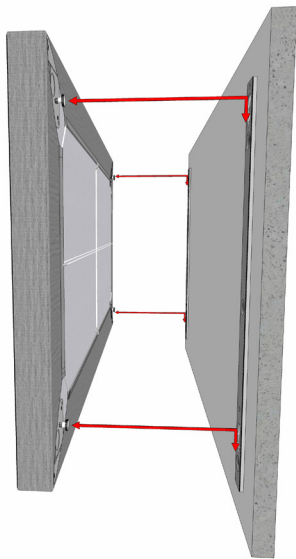

Collection : AirPanel / Gamme Acoustic 0.7  
Date de parution : Mars 2017

 **texdecor**  
PANEL

siège social – head office  
2 rue d'hem - 59780 Willems - France  
tel +33 (0)3 20 61 78 37 / Fax +33 (0)3 20 61 75 64  
[www.texdecor.fr](http://www.texdecor.fr)

## FIXATION AU PLAFOND PAR CABLES VERTICAUX

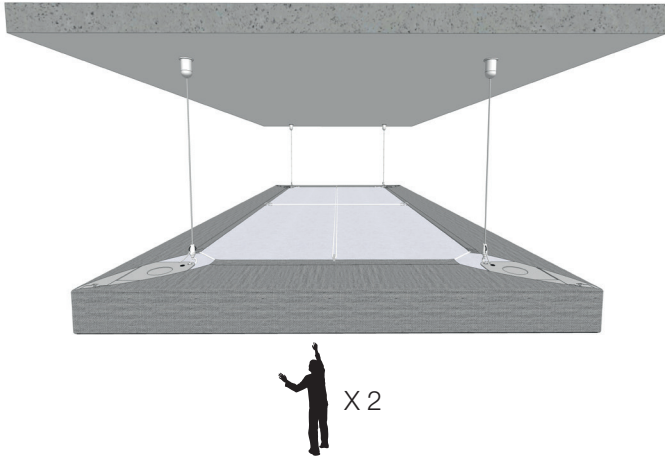

## FOURNITURES LIVRÉES

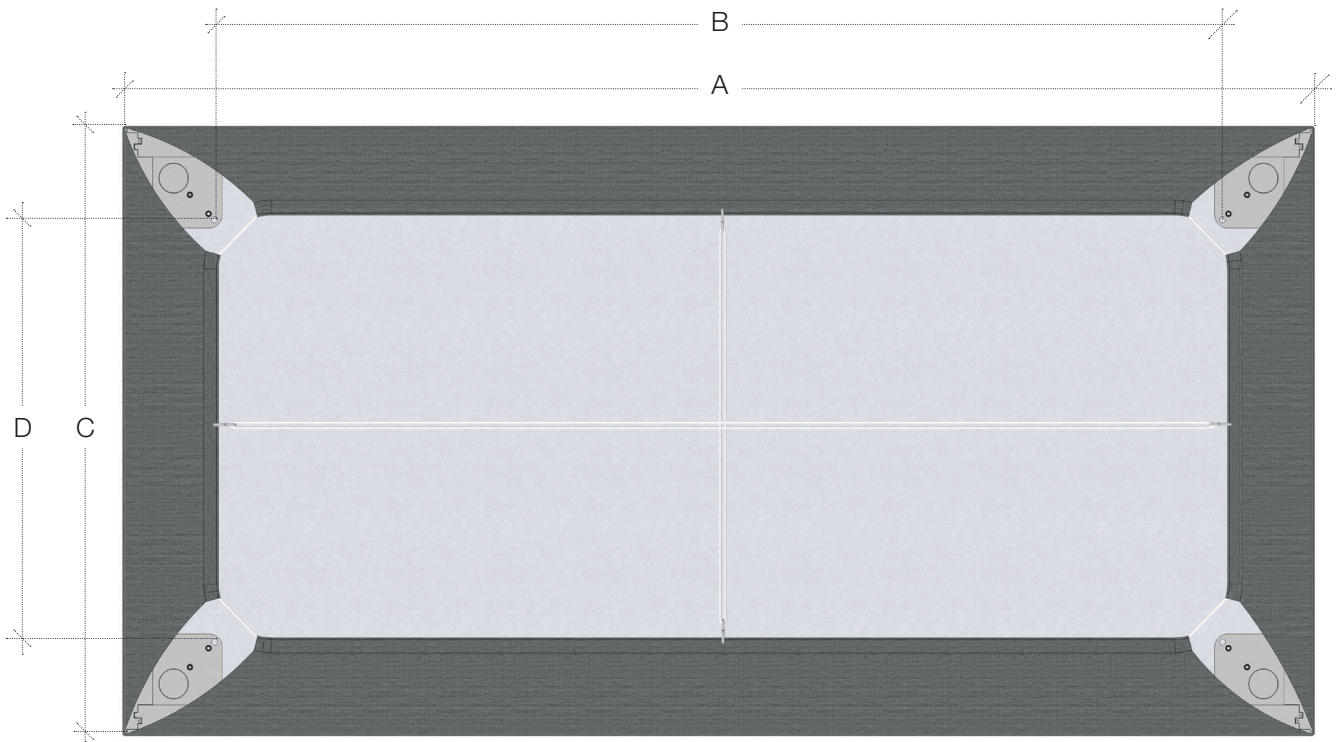
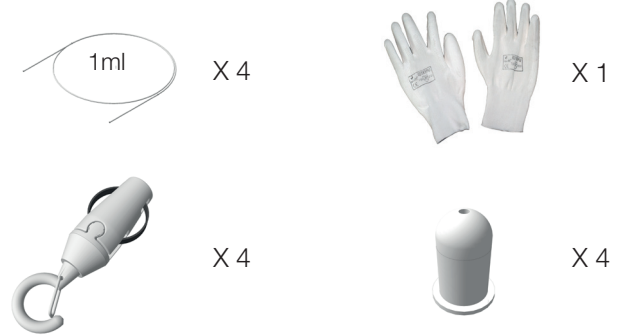

Exemple d'illustration du panneau 1200 x 600

Panneau	A	B	C	D	
1200 x 1200	1200 (mm)	1017	1200	1017	8,5 kg
1200 x 600	1200	1017	600	417	4,25 kg
600 x 600	600	417	600	417	3,87 kg
1200 x 300	1200	1017	300	117	3,87 kg
2400 x 300	2400	2218,5	300	117	5,3 kg
2400 x 600	2400	2218,5	600	417	9,7 kg
1800 x 300	1800	1618,5	300	117	4,25 kg
1800 x 600	1800	1618,5	600	417	6,37 kg
600 x 300	600	417	300	117	1,96 kg
2400 x 1200	2400	2218,5	1200	1017	17 kg

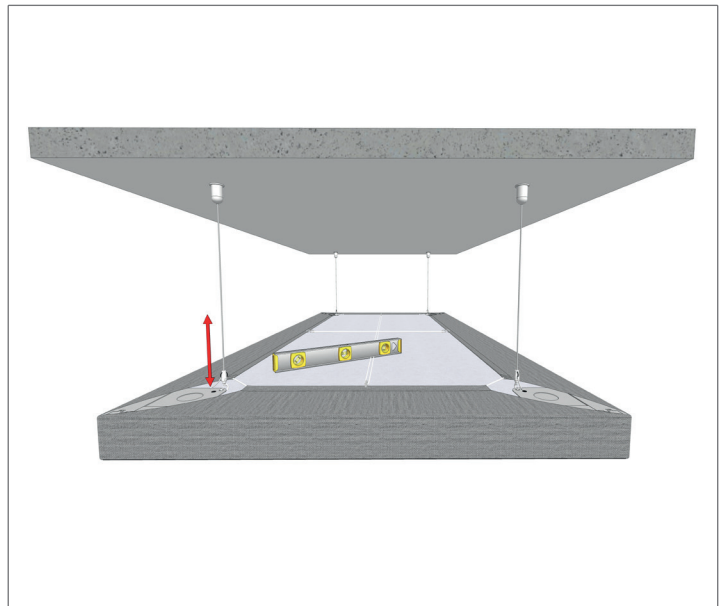
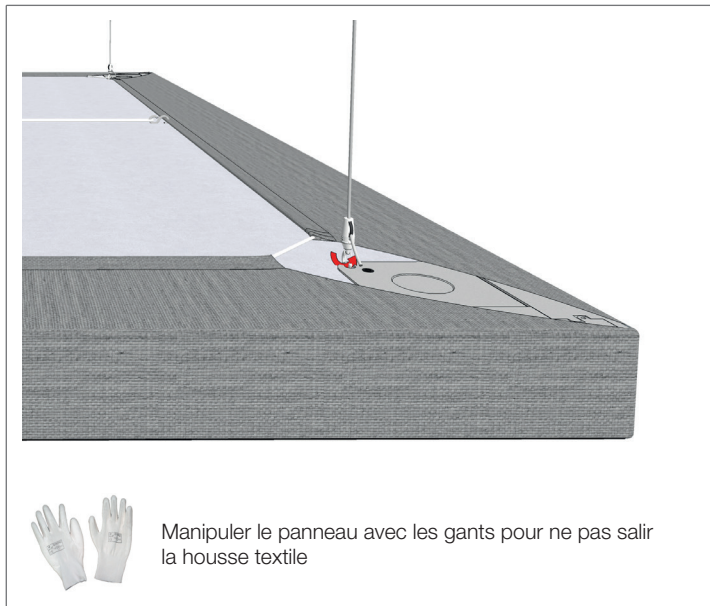
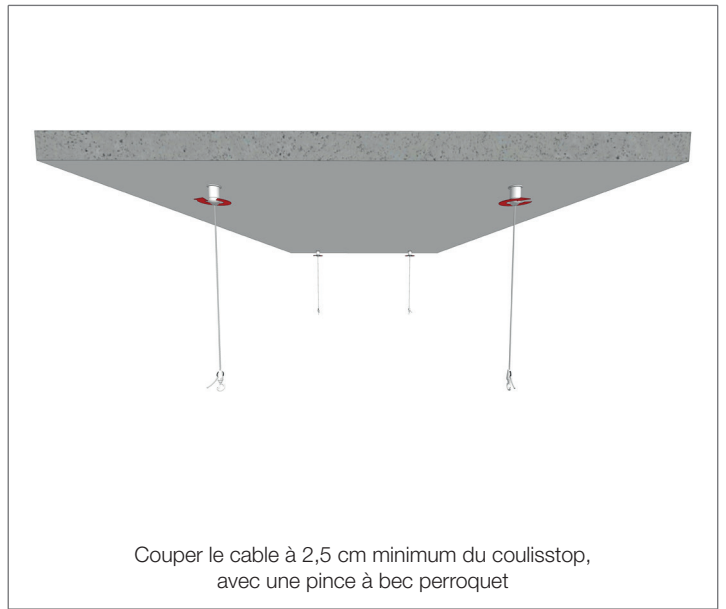
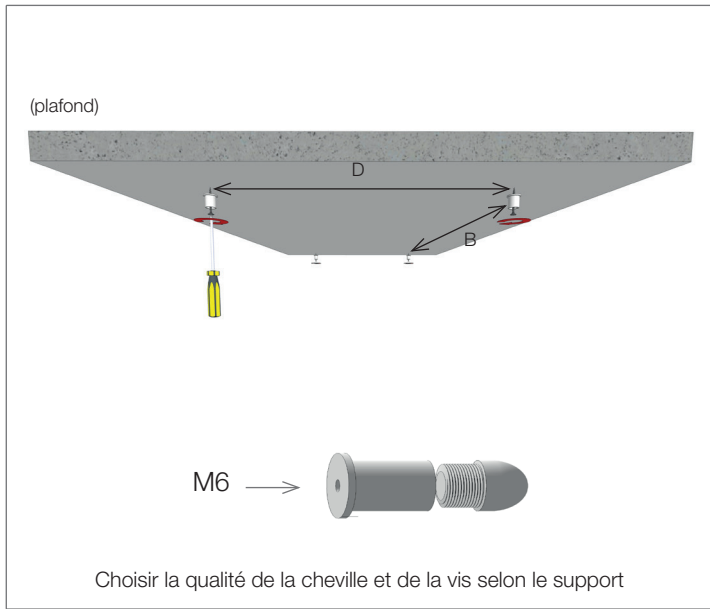

Collection : AirPanel / Gamme Acoustic 0.7  
Date de parution : Février 2017

 **texdecor**  
PANEL

siège social – head office  
2 rue d'hem - 59780 Willems - France  
tel +33 (0)3 20 61 78 37 / Fax +33 (0)3 20 61 75 64  
[www.texdecor.fr](http://www.texdecor.fr)



## POSE DE LA DALLE AU PLAFOND



## FOURNITURES LIVRÉES

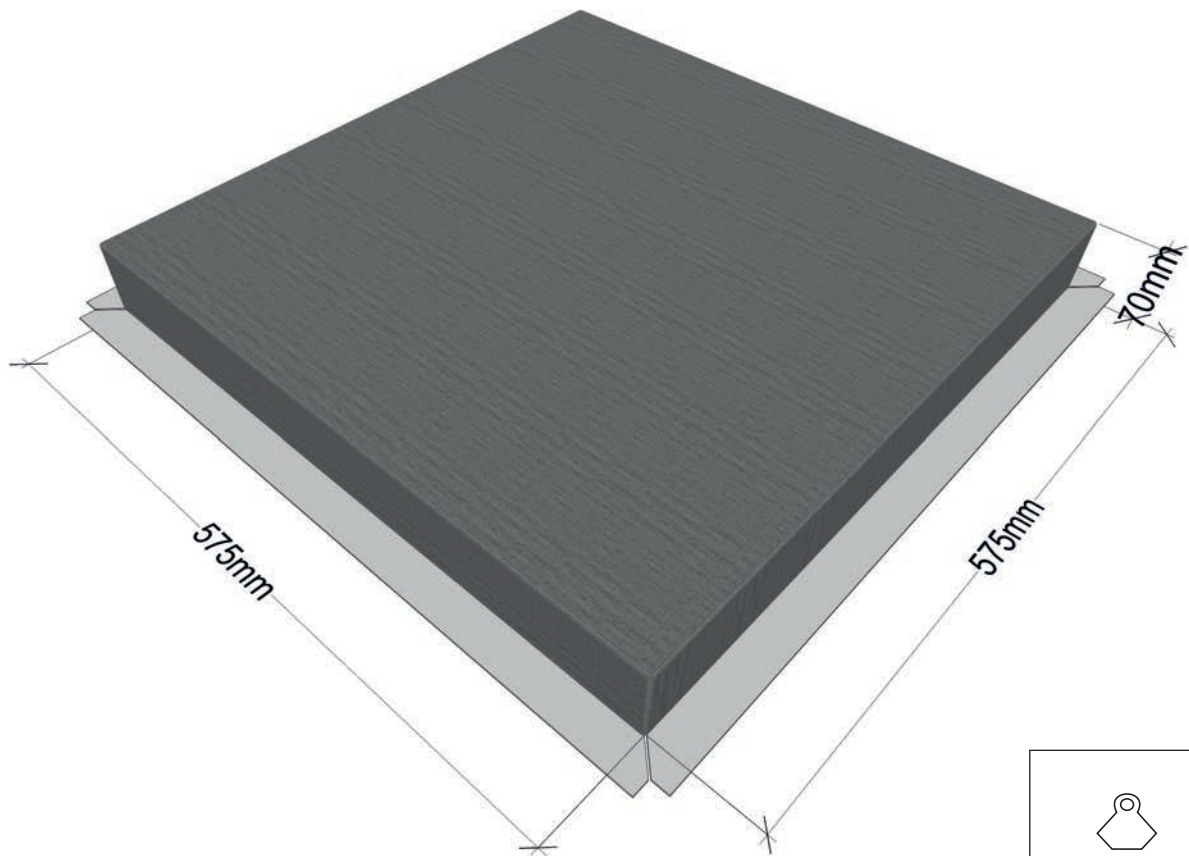

2,17KG



Collection : AirPanel / Gamme Acoustic 0.7  
Date de parution : Mars 2017

**texdecor**  
PANEL

siège social – head office  
2 rue d'hem - 59780 Willems - France  
tel +33 (0)3 20 61 78 37 / Fax +33 (0)3 20 61 75 64  
[www.texdecor.fr](http://www.texdecor.fr)

## FIXATION AU MUR SUR RAIL MÉTALLIQUE

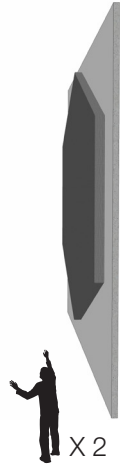

## FOURNITURES LIVRÉES

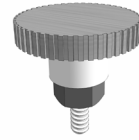

X 4



X 1

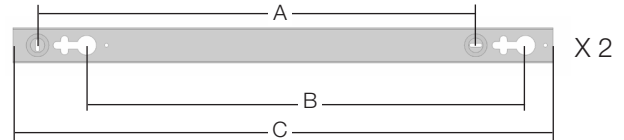

Rail	A	B	C
600	464	467,1	570

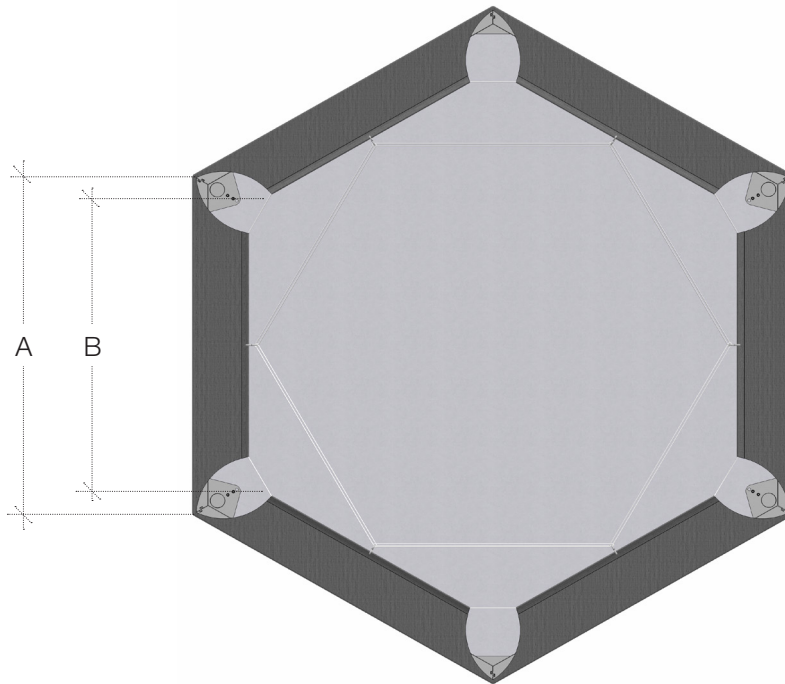

Panneau	A	B	
Hexagone 1200	600 (mm)	524,5	6,04 kg

Choisir la qualité de la cheville et de la vis selon le support

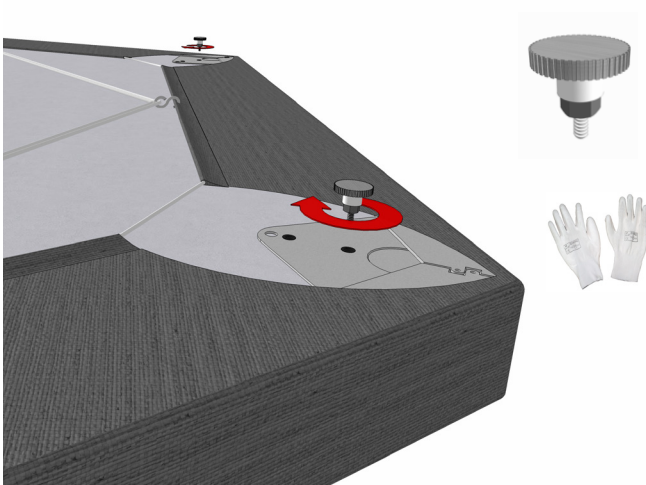
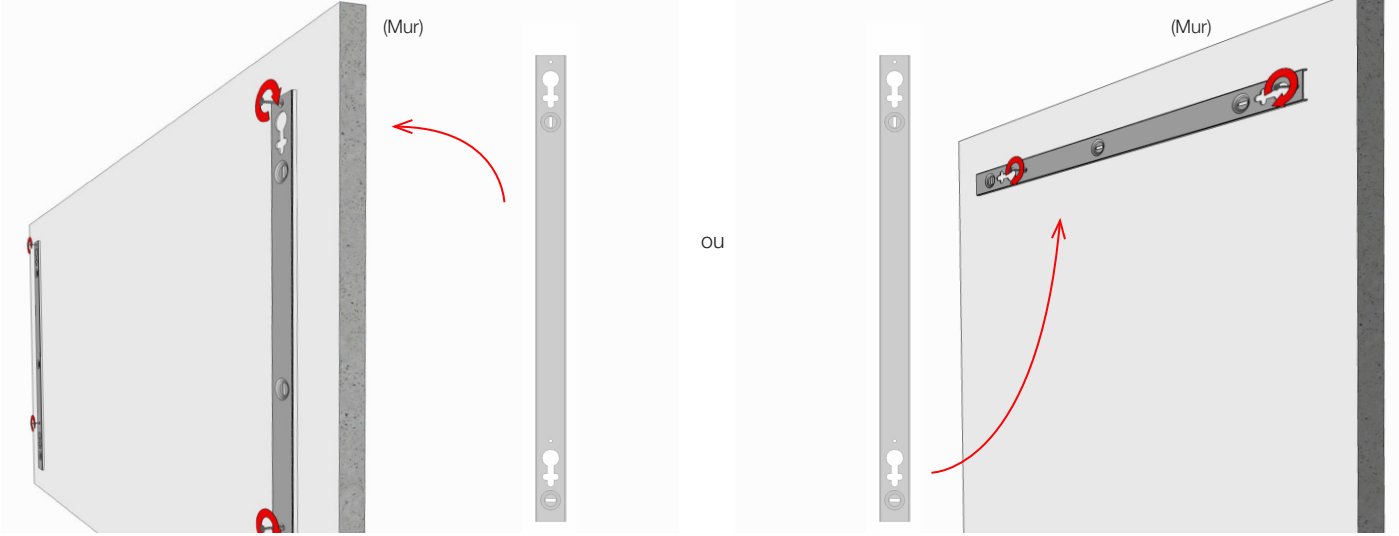

Manipuler le panneau avec les gants pour ne pas salir la housse textile

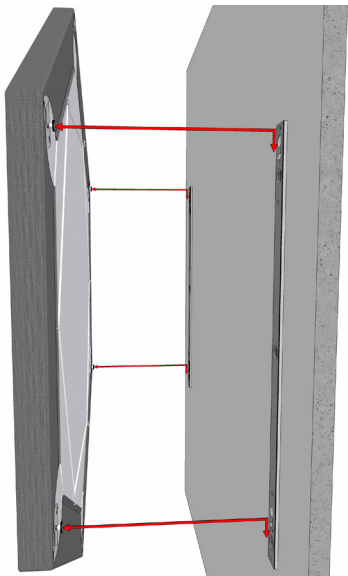

Collection : AirPanel / Gamme Acoustic 0.7  
Date de parution : Juin 2017

 **texdecor**  
PANEL

siège social – head office  
2 rue d'hem - 59780 Willems - France  
tel +33 (0)3 20 61 78 37 / Fax +33 (0)3 20 61 75 64  
[www.texdecor.fr](http://www.texdecor.fr)

## FIXATION AU MUR PAR AIMANTS

ATTENTION : Ne convient pas au plafond

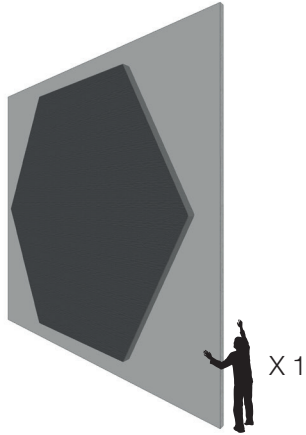

## FOURNITURES LIVRÉES

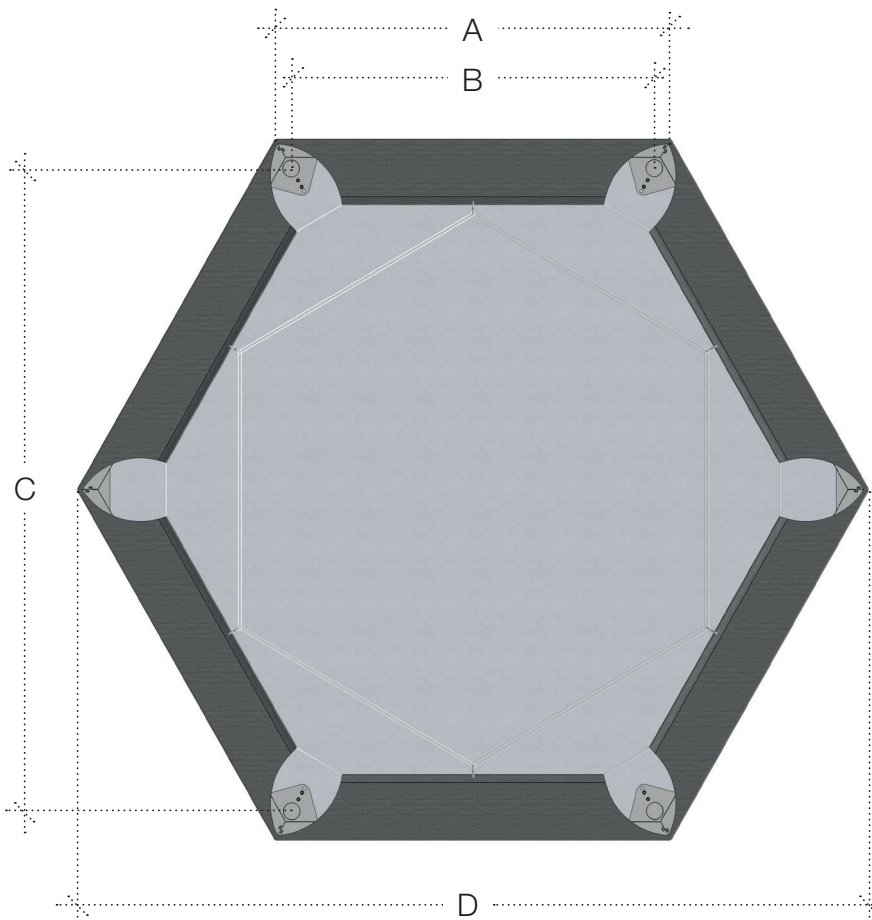
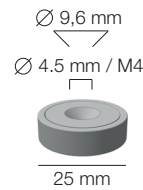

Exemple d'illustration du panneau Hexagone 1200

Panneau	A	B	C	D	
1200 x1200	610 (mm)	545	940	1210	6,04 kg

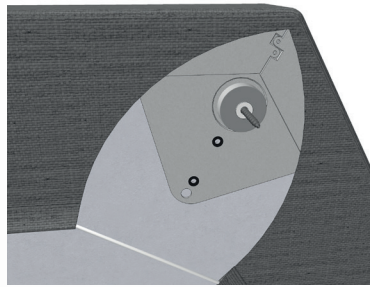
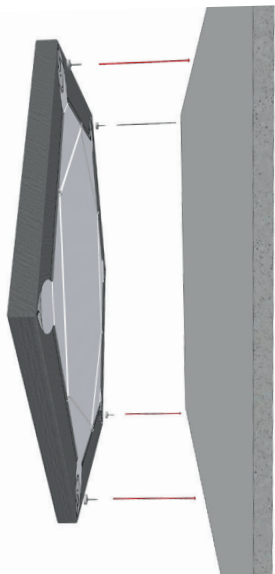

Utiliser les entraxes pour repérer l'emplacement des aimants  
ou plaquer les aimants avec les vis sur le panneau pour marquer  
leur positionnement sur le mur.

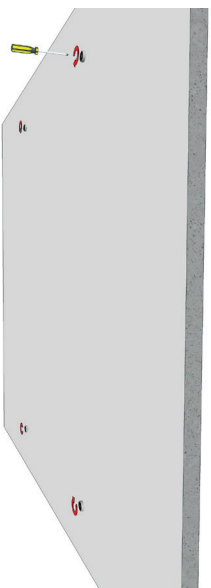

La rondelle caoutchouc permet de corriger les légers défauts de  
planéité du mur, afin de garantir un contact optimal entre la platine du  
cadre et l'aimant.

Visser l'aimant en butée, sans écraser la rondelle.

Choisir la qualité de la cheville et de la vis selon le support.



Manipuler le panneau avec les gants pour ne pas salir  
la housse textile

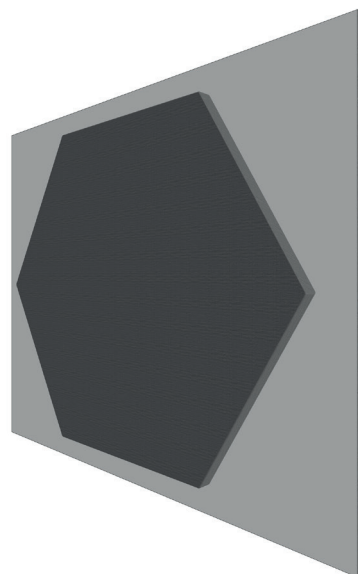
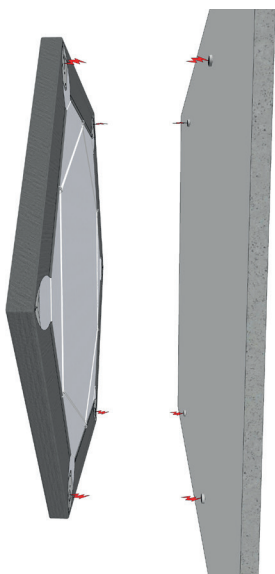

Collection : AirPanel / Gamme Acoustic 0.7  
Date de parution : Juillet 2017

## FIXATION AU PLAFOND PAR CABLES VERTICAUX

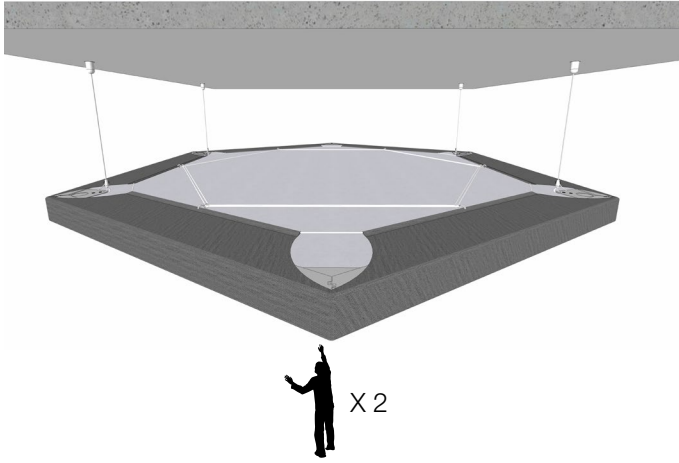

## FOURNITURES LIVRÉES

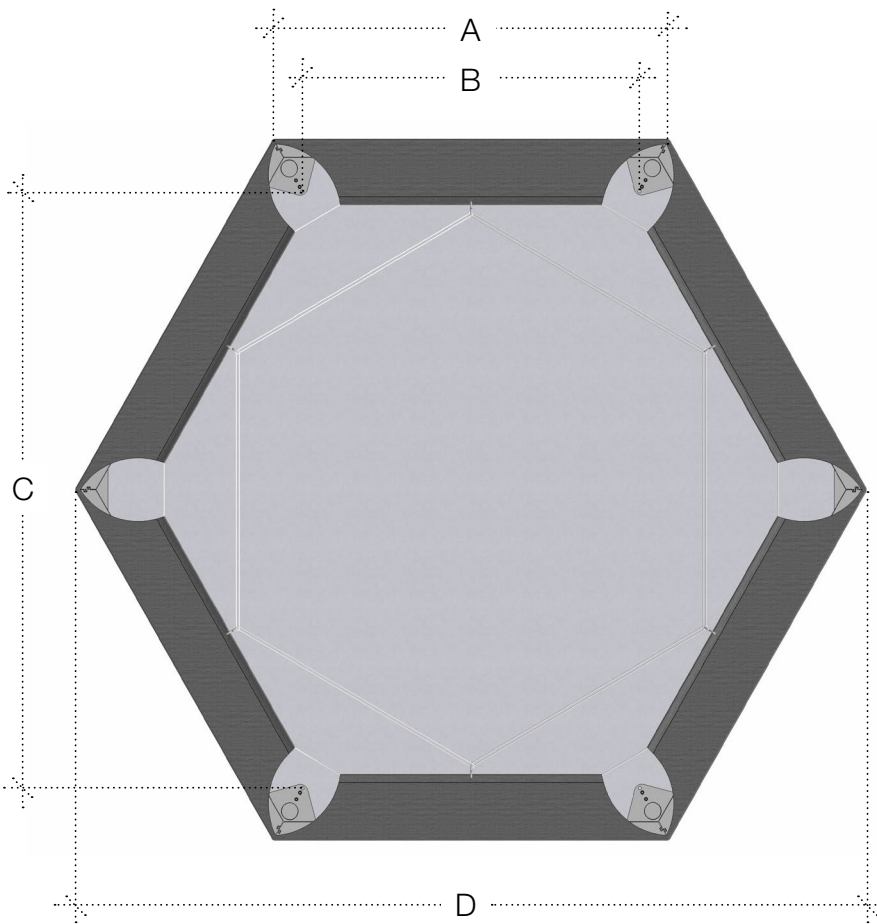

Exemple d'illustration du panneau Hexagone 1200

Panneau	A	B	C	D	
1200 x 1200	610 (mm)	487	835	1210	6,04 kg

(plafond)

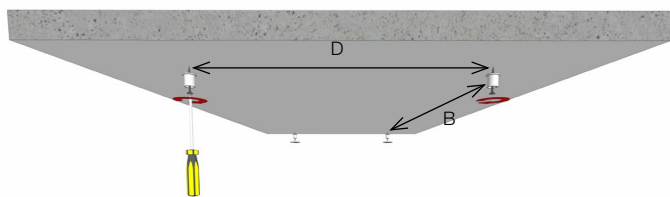

M6

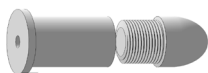

Choisir la qualité de la cheville et de la vis selon le support

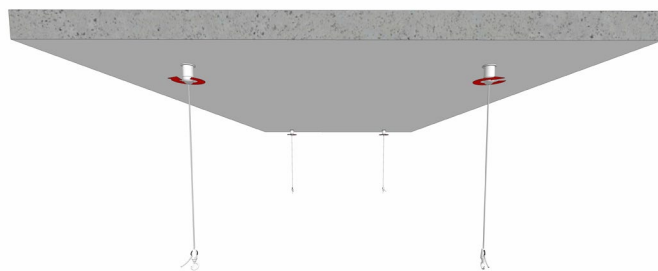

Couper le câble à 2,5 cm minimum du coulisstop, avec une pince à bec perroquet

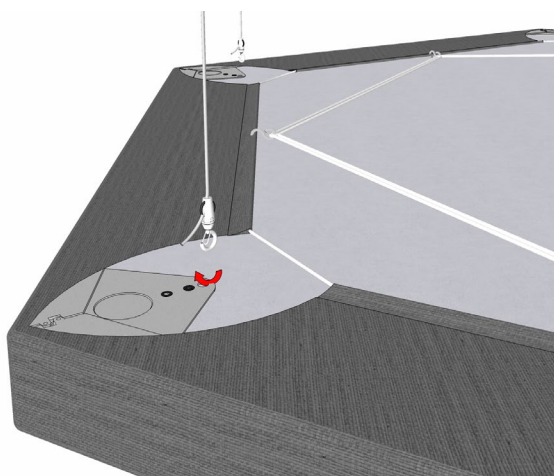

Manipuler le panneau avec les gants pour ne pas salir la housse textile

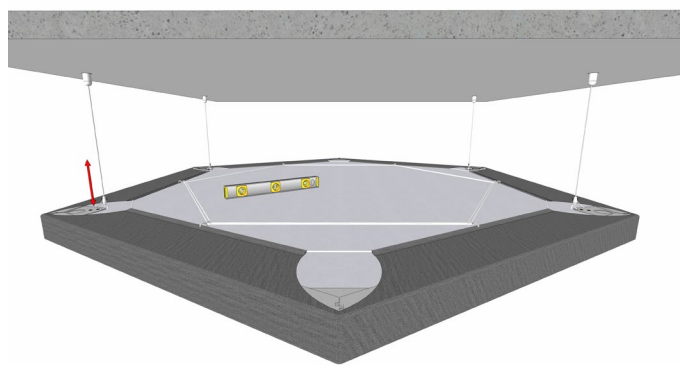

Collection : AirPanel / Gamme Acoustic 0.7  
Date de parution : Juillet 2017

 **texdecor**  
PANEL

siège social – head office  
2 rue d'hem - 59780 Willems - France  
tel +33 (0)3 20 61 78 37 / Fax +33 (0)3 20 61 75 64  
[www.texdecor.fr](http://www.texdecor.fr)



## FIXATION AU MUR SUR RAIL MÉTALLIQUE



## FOURNITURES LIVRÉES PAR PANNEAU

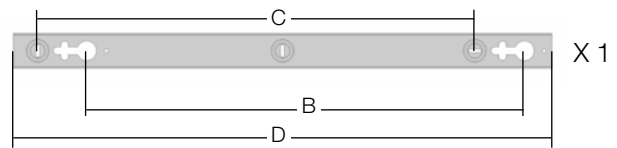
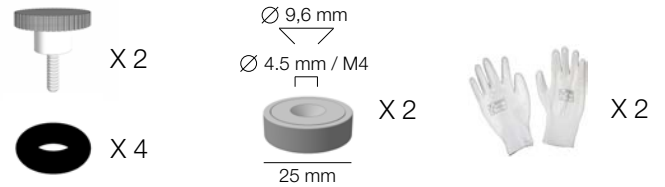

Rail	C	B	D
600	507	524,5	626

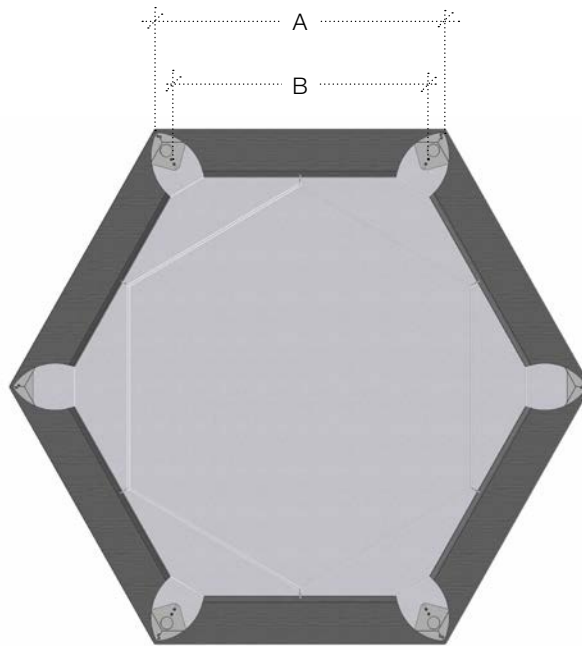

Panneau	A	B	
Hexagone 1200	600 (mm)	524,5	6,04 kg

## DEUX SENS DE POSE



Si la pose se fait en butée contre un mur à gauche, la pose se fait de gauche à droite puis de bas en haut.



Si la pose se fait en butée contre un mur à droite, la pose se fait de droite à gauche puis de bas en haut.



Exemple de pose de gauche à droite :

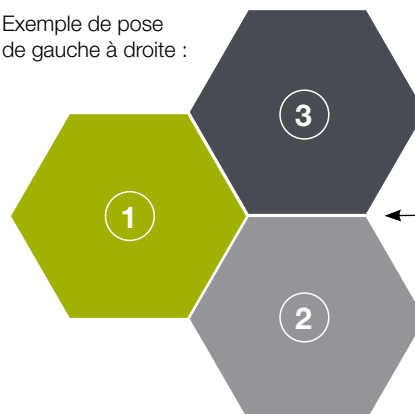

espace de dilatation et d'ajustement nécessaire (4-5 mm).

### Fixation des rails et des aimants

Choisir la qualité de la cheville et de la vis selon le support

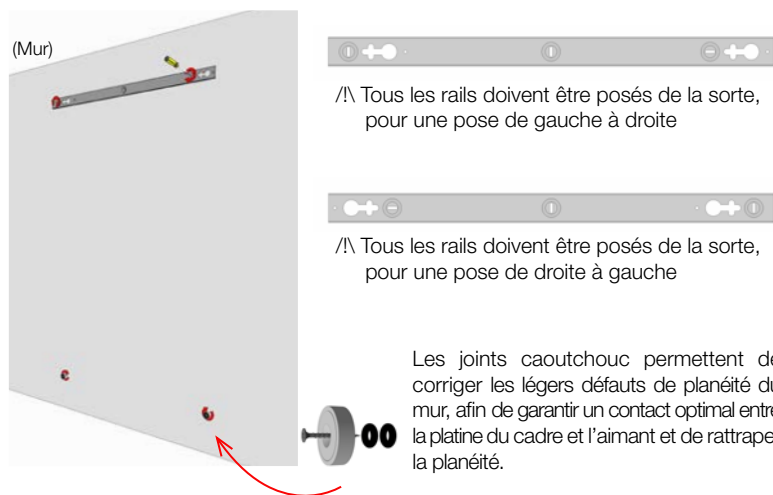

/!\ Tous les rails doivent être posés de la sorte, pour une pose de gauche à droite

/!\ Tous les rails doivent être posés de la sorte, pour une pose de droite à gauche

Les joints caoutchouc permettent de corriger les légers défauts de planéité du mur, afin de garantir un contact optimal entre la platine du cadre et l'aimant et de rattraper la planéité.

Visser l'aimant en butée, sans écraser les joints.

### Préparation du panneau

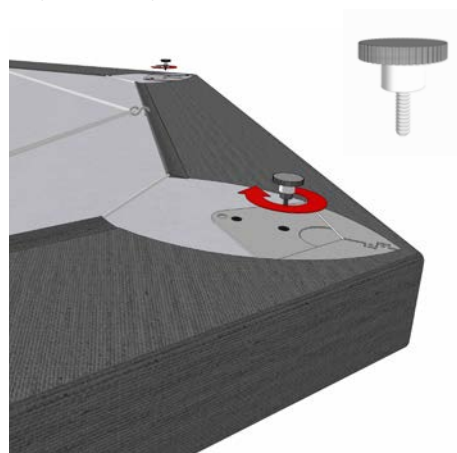

Manipuler le panneau avec les gants pour ne pas salir la housse textile

### Pose du panneau

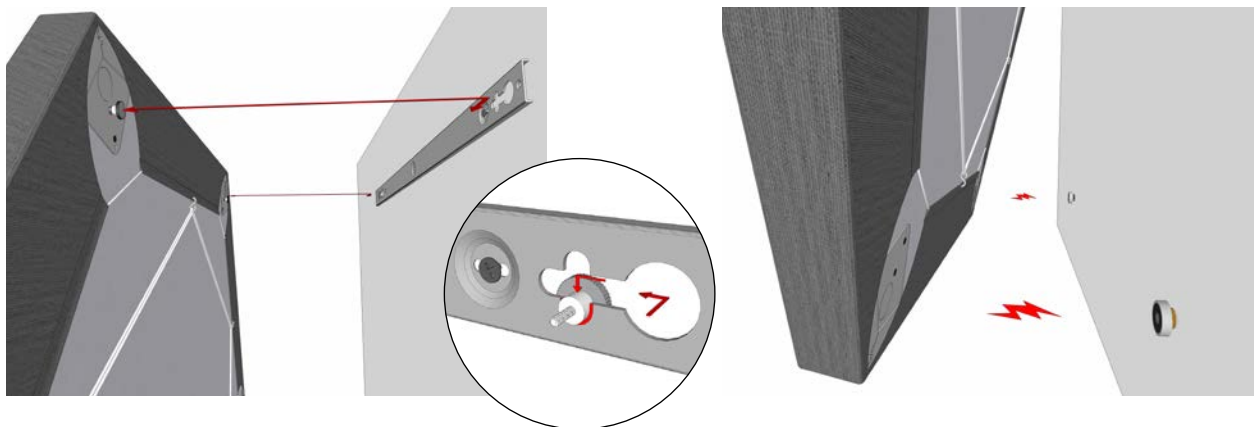

Glisser le panneau dans le rail de la droite vers gauche (ou inversement), puis vers le bas dans son logement.

Puis mettre en contact le panneau contre les aimants

Collection : AirPanel / Gamme Acoustic 0.7  
Date de parution : Juin 2017

 **texdecor**  
PANEL

siège social – head office  
2 rue d'hem - 59780 Willems - France  
tel +33 (0)3 20 61 78 37 / Fax +33 (0)3 20 61 75 64  
[www.texdecor.fr](http://www.texdecor.fr)

## FIXATION AU MUR PAR AIMANT

ATTENTION : Ne convient pas au plafond

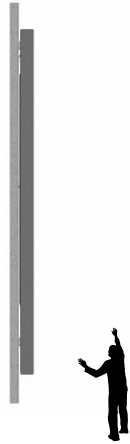

## FOURNITURES LIVRÉES PAR PANNEAU

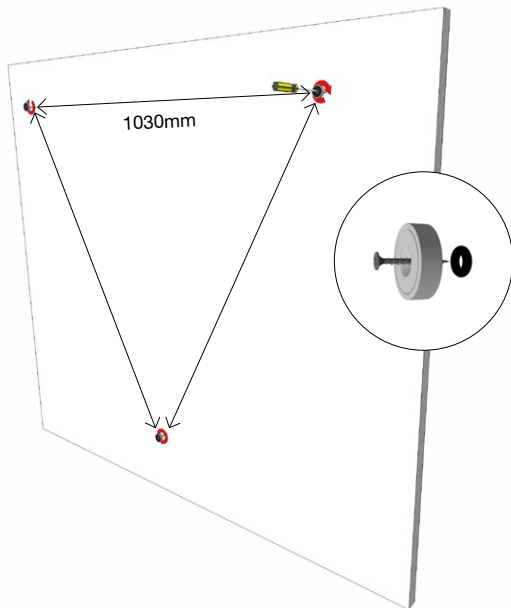
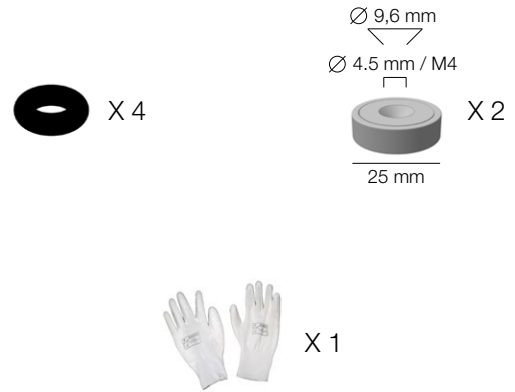

La rondelle caoutchouc permet de corriger les légers défauts de planéité du mur, afin de garantir un contact optimal entre la platine du cadre et l'aimant.

Visser l'aimant en butée, sans écraser la rondelle.

Choisir la qualité de la cheville et de la vis selon le support.



Manipuler le panneau avec les gants pour ne pas salir la housse textile

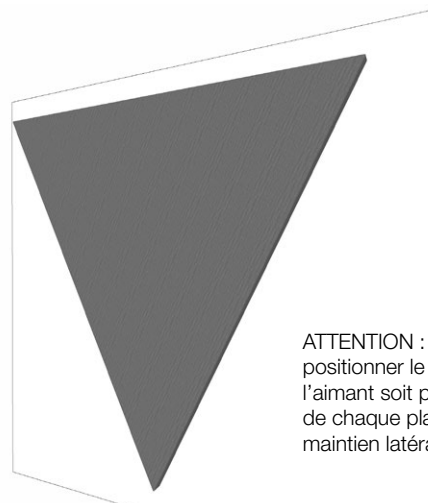
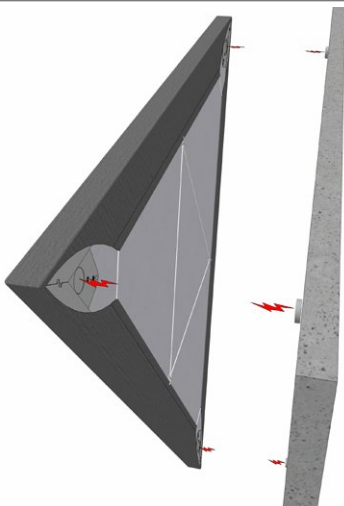

ATTENTION :  
positionner le cadre de telle sorte que l'aimant soit placé dans la cavité ronde de chaque platine, afin de garantir le maintien latéral optimal su panneau.

## FIXATION AU PLAFOND PAR CABLES VERTICAUX

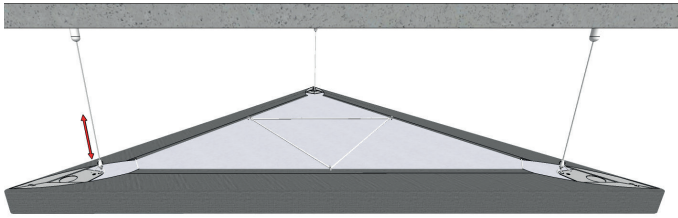

## FOURNITURES LIVRÉES

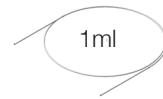

X 3



X 1



X 3



X 3

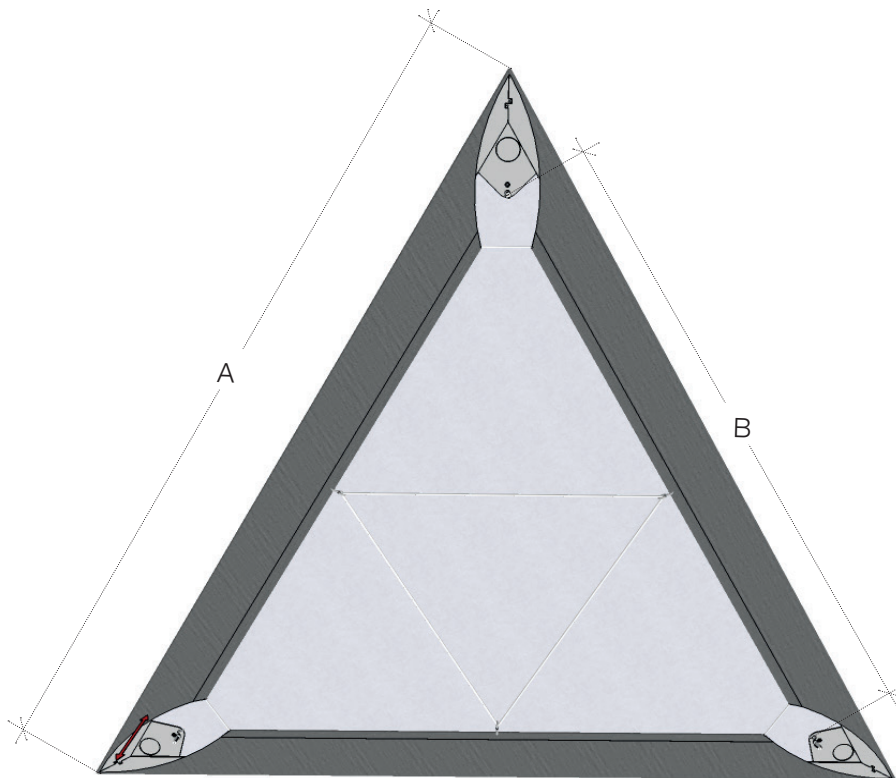

Exemple d'illustration du panneau TRI 1200

Panneau	A	B	C	D	E	
TR 1200	1200 (mm)	992	992	1200	1200	4,2 kg

(plafond)

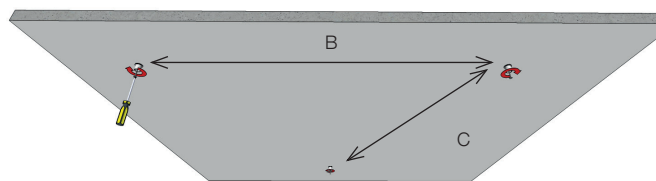

M6

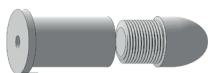

Choisir la qualité de la cheville et de la vis selon le support

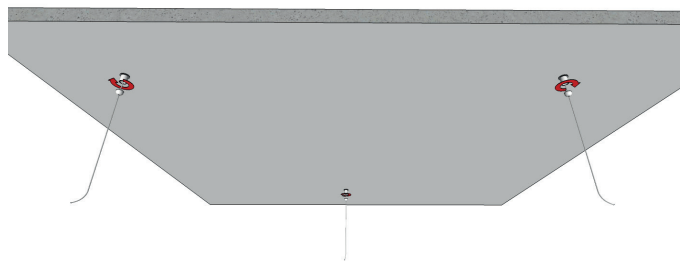

Couper le câble à 2,5 cm minimum du coulisstop, avec une pince à bec perroquet

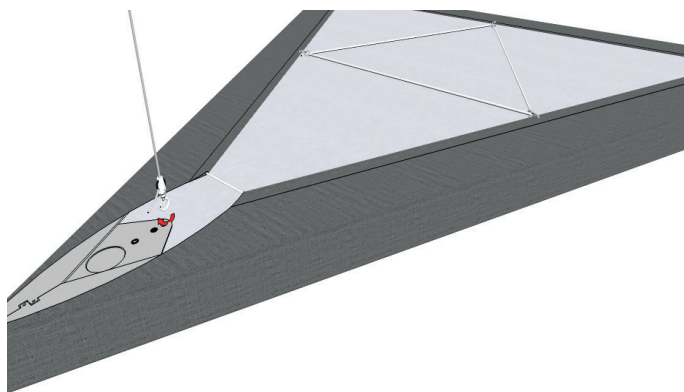

Manipuler le panneau avec les gants pour ne pas salir la housse textile

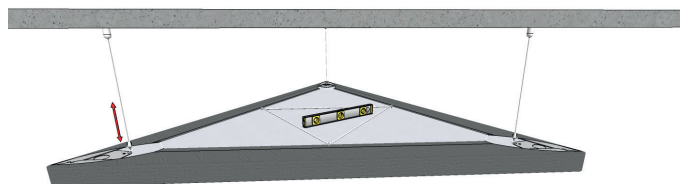

Collection : AirPanel / Gamme Acoustic 0.7  
Date de parution : Avril 2016

 **texdecor**  
PANEL

siège social – head office  
2 rue d'hem - 59780 Willems - France  
tel +33 (0)3 20 61 78 37 / Fax +33 (0)3 20 61 75 64  
[www.texdecor.fr](http://www.texdecor.fr)